

# GUIDE TO ATTIC AIR SEALING

## IDENTIFYING AND BLOCKING AIR LEAKAGE PATHWAYS PROVIDING AIRTIGHT CLOSURE

Attics should be air sealed prior to adding insulation. Adding insulation alone does not save much energy and can lead to health and durability problems. The intent of this guide is to provide information for the preparation work necessary prior to adding attic insulation.

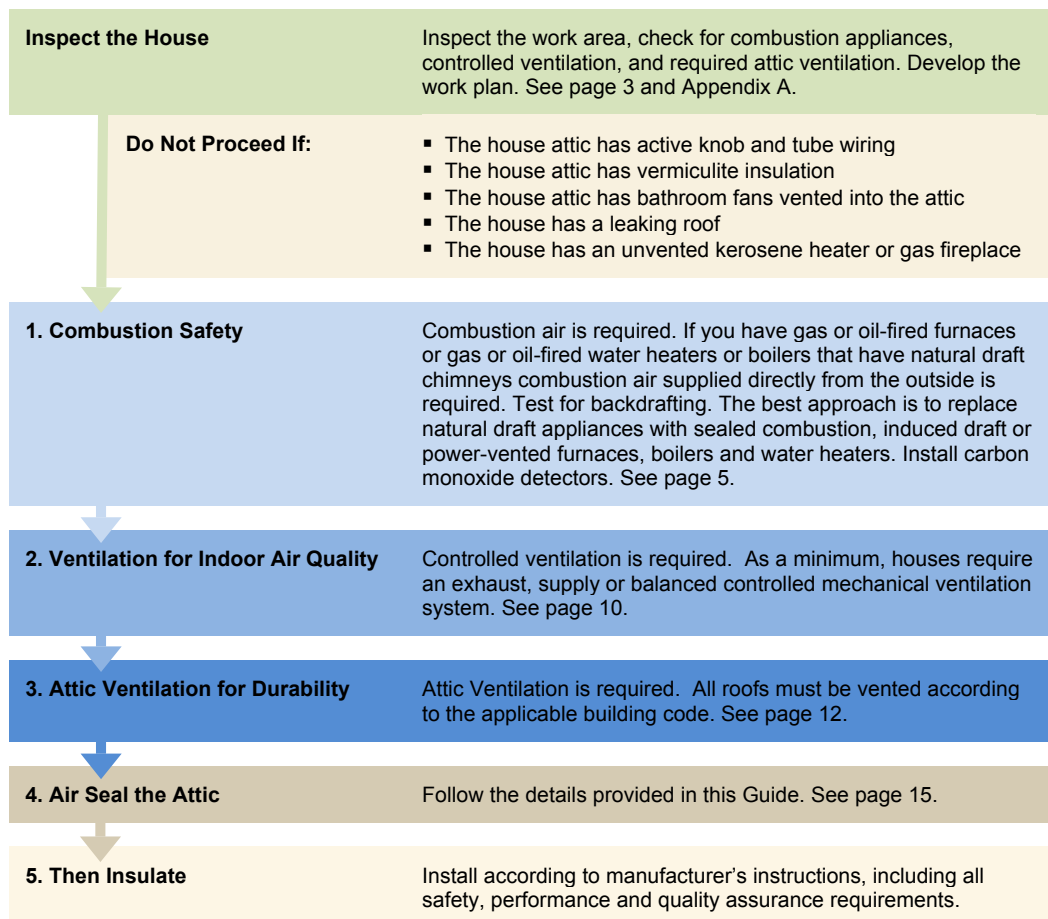

The guide to Guide to Attic Air Sealing provides information and specifications to the following groups:

- Home remodelers
- Builders
- Insulation contractors
- Mechanical contractors
- General contractors who have previously done remodeling
- Homeowners as a guide to the work that needs to be done

The order of work to be done during home improvements is important. Health and safety issues must be addressed first and are more important than durability issues. And durability issues are more important than saving energy.

Even though the purpose of this guide is to save energy – health, safety and durability should not be compromised by energy efficiency. Accordingly, combustion safety and ventilation for indoor air quality are addressed first. Durability and attic ventilation then follow. Finally, to maximize energy savings, air sealing is completed prior to insulating.

This guide is prescriptive-based to minimize risks. Enhanced performance and greater energy savings are possible with performance-based approaches. Performance-based approaches should build on the measures and specifications contained in this guide.

Not all techniques can apply to all houses. Special conditions will require special action. Some homeowners will wish to do more than the important but basic retrofit strategies outlined by this guide. Where possible throughout the manual, links have been made to “performance” path solutions that require the judgment and experience of design professionals and specialist skills and experience.

**Written by: Joseph Lstiburek, Ph.D., P.Eng.**

Building Science Corporation  
30 Forest Street  
Somerville, MA 01243  
(978) 589-5100  
[www.buildingscience.com](http://www.buildingscience.com)

## Acknowledgements

The author would like to acknowledge the funding and support of the US Department of Energy's Building America Program. This Guide is the product of a collaborative effort. Special thanks to Stephanie Finnegan, Bohdan Boyko, Ren Anderson and Alex Lukachko.

## Notice

This report was prepared as an account of work sponsored by an agency of the United States government. Neither the United States government nor any agency thereof, nor any of their employees, makes any warranty, express or implied, or assumes any legal liability or responsibility for the accuracy, completeness, or usefulness of any information, apparatus, product, or process disclosed, or represents that its use would not infringe privately owned rights. Reference herein to any specific commercial product, process, or service by trade name, trademark, manufacturer, or otherwise does not necessarily constitute or imply its endorsement, recommendation, or favoring by the United States government or any agency thereof. The views and opinions of authors expressed herein do not necessarily state or reflect those of the United States government or any agency thereof.

Note: For homeowners and contractors unfamiliar with working in attics, the following safety issues should be addressed:

- a. Be aware of head injury, especially nails in sheathing below roof.
- b. Wear proper personal protective equipment such as a mask for avoiding breathing in excessive dust and long sleeves to avoid skin irritation.
- c. Be prepared to walk among difficult obstacles along narrow walking boards or on ceiling joists with minimal hand holds. Do not step on insulation or gypsum board ceiling.
- d. Be aware that you are working in a confined space, ensure that adequate ventilation is available.

## Inspect the House

Before any air sealing work is done, inspect the work area. Check first for active knob and tube wiring, vermiculite insulation, bathroom fans vented into attics, leaking roofs, and unvented kerosene heaters or gas fireplaces.

**Note on Vermiculite:** this insulation may be contaminated with asbestos. For more information, see:

[www.epa.gov/asbestos/pubs/verm.html](http://www.epa.gov/asbestos/pubs/verm.html)

### STOP WORK – do not proceed:

**IF** the house attic has active knob and tube wiring.

**THEN** the house must be rewired prior to the attic being air sealed and insulated.

**IF** the house attic has vermiculite insulation.

**THEN** professional advice should be obtained. The vermiculite insulation may contain asbestos and must be tested prior to the attic being air sealed and insulated. Contact your State Department of Health.

**IF** the attic has bathroom fans vented into the attic.

**THEN** bathroom fans must be vented to the outside prior to the attic being air sealed and insulated.

**IF** the house has a leaking roof.

**THEN** the leaking roof must be fixed prior to the attic being air sealed and insulated.

**IF** there is an unvented kerosene heater or gas fireplace.

**THEN** the unvented heater or fireplace must be vented or removed prior to the attic being air sealed and insulated.

Check next for combustion appliances, controlled ventilation, and required attic ventilation. The following health, safety and durability issues must be addressed:

### 1. Combustion Safety.

If you have gas- or oil-fired furnaces or gas- or oil-fired water heaters that have natural draft chimneys, combustion air supplied directly from the outside is required. If natural draft gas or oil appliances are present and a dedicated source of combustion air supply from the outside is not present, then a qualified mechanical or plumbing contractor in the State must be engaged to provide this source of combustion air. Carbon monoxide detectors are required to be installed if the house has combustion appliances.

The best approach is to replace natural draft appliances with sealed combustion, induced draft, or power-vented furnaces, boilers, and water heaters. They are significantly more energy efficient than natural draft appliances and, when installed according to manufacturers installation instructions, they do not require a duct supplying outside combustion air as described here.

More information about Combustion Safety for oil and gas appliances is provided in this Guide on page 5.

**Definition – Combustion Air:** the air provided to fuel-burning equipment including air for fuel combustion, draft hood dilution and ventilation of the equipment enclosure (IRC 2009 Section R202). Also see: [www.cpsc.gov/cpsc/pub/pubs/452.html](http://www.cpsc.gov/cpsc/pub/pubs/452.html)

## 2. Controlled Ventilation for Indoor Air Quality.

At a minimum, houses require an exhaust, supply or balanced controlled mechanical ventilation system. If a controlled mechanical ventilation system is not present, one should be installed by a qualified contractor.

More information on Controlled Ventilation options is provided in this Guide on page 10.

**Definition – Controlled Ventilation:** The process of supplying outdoor air to or removing indoor air from a dwelling by a fan or fans. See example on page 10.

**Reference –** ASHRAE Standard 62.2 – 2010: Ventilation and Acceptable Indoor Air Quality in Low Rise Residential Buildings

## 3. Attic Ventilation for Durability.

All roofs must be vented according to the applicable building code. If the roof is not vented according to the applicable building code then a qualified contractor in the State should be engaged to install the necessary venting.

More information on Attic Ventilation for houses with and without soffit vents is provided in this Guide on page 12.

**Definition – Attics:** The space between the underside of the roof deck sheathing and the topside of the top story ceiling. This space does not include cathedral ceilings.

**Definition – Attic Ventilation:** The intentional flow of outdoor air into an attic space balanced by the intentional flow of attic air to the outside by natural means. The primary function of attic ventilation is to control moisture accumulation and ice dam formation (in certain climates).

### Air Seal the Attic

Once the issues identified above have been addressed, proceed to develop the attic air sealing work plan. Air sealing details for most common attic situations are provided in this Guide on page 15. A sample work plan can be found in Appendix A.

Other Guides for air sealing are available. The Guide to Attic Duct Sealing provides important information for houses with ductwork and other mechanical system components located in the attic. If applicable, information from the other Guides should be considered when developing the attic air sealing work plan.

### Air Sealing, Combustion Air and Saving Energy

Energy is saved when holes between conditioned areas and unconditioned attics are sealed even if a necessary hole is then added to supply combustion air. The logic is both intuitive and counter-intuitive. First, in most houses the surface area of holes sealed in the attic will be much greater than the surface area of the hole added to provide combustion air. The house, therefore, ends up with fewer holes.

Second, not all holes are alike. Holes up high leak more air than holes down low. This is because houses are like hot air balloons that are too heavy to leave the ground. A hole at the bottom of the hot air balloon does not matter much, but a hole at the top of the hot air balloon matters a great deal. Sealing a hole up high in an attic and then adding a hole of equal size down near a furnace actually reduces air leakage and saves energy.

Most importantly, sealing holes in attics makes chimneys work better. A leaky attic ceiling acts like a chimney itself – and this “attic ceiling chimney” competes with the real chimney for the same air.

Air sealing the leaky attic ceiling also reduces the “suction” of the house on the ground under the house so less contaminants are drawn into the house such as radon and other soil gases. The more air that leaves the top of a house, the more air that is drawn (or sucked) in at the bottom of a house. Sealing the top of a house reduces the entry of contaminants and air at the bottom of a house – even if a hole is present at the bottom of the house.

### Consider Upgrading Existing Appliances

The best approach to combustion safety is to replace natural draft appliances with sealed combustion, induced draft or power-vented furnaces, boilers and water heaters. These types of appliances are significantly more energy efficient than natural draft appliances and when installed according to manufacturers installation instructions they do not require a duct supplying outside combustion air as described here.

### If the House has Gas Appliances . . .

Gas-fired furnaces, boilers and water heaters that have natural draft chimneys require combustion air. It should be supplied from the outside by a duct. If these ducts are not sized correctly or if they are blocked this can result in incomplete combustion of the fuel and can lead to backdrafting. Backdrafting occurs when hazardous exhaust gasses enter into the house rather than exit through the flue. The requirements for gas appliances are slightly different than those for oil appliances. Houses with appliances with natural draft chimneys, even if combustion air is supplied directly from the outside, should be tested for backdrafting.

Additionally, if the house has combustion appliances, carbon monoxide detectors complying with UL 2034 are required in close proximity to the combustion appliances and outside each separate sleeping area in the immediate vicinity of the bedrooms.

**Note:** There are some important openings that should not be sealed. Combustion air ducts and soffit, ridge and gable vents are all intentional openings that must be kept open to air movement in order to work properly.

**Combustion safety** – for more information, see: [www.cpsc.gov/cpsc/pub/pubs/452.html](http://www.cpsc.gov/cpsc/pub/pubs/452.html) and [www.epa.gov/iaq/homes/hip-combustion.html](http://www.epa.gov/iaq/homes/hip-combustion.html)

**Reference** – 2009 International Fuel Gas Code; Appendix D: Recommended Procedure for Safety Inspection of an Existing Appliance Installation.

**Reference** – 2009 International Residential Code For One- and Two-Family Dwellings: Chapter 3 - Building Planning; Section R315 Carbon Monoxide Alarms.

**Provide Combustion Air for Gas Appliances**

A duct supplying outside combustion air is required for all natural draft gas-fired furnaces and natural draft gas-fired water heaters. The size of this duct is determined by the sum of the Btu input into both appliances and TABLE 1 (below).

**Note** – Homes may have more than one combustion air zone. In other words, combustion appliances may be located in more than one part of a house - in different areas. Each zone needs to be treated separately.

**TABLE 1: Gas-fired Appliances – SINGLE OPENING TO OUTSIDE**

Total input rating of all Appliances in space (Btu)		One Exterior Opening	
from	to	Free Area (sq in)	Duct Diameter (in)
0	23,999	7	3
24,000	38,999	13	4
39,000	59,999	20	5
60,000	86,999	28	6
87,000	116,999	38	7
117,000	152,999	50	8
153,000	191,999	64	9
192,000	236,999	79	10

**Reference** – Gas Appliances: 2009 International Residential Code for One- and Two-Family Dwellings; Chapter 24, Fuel Gas; Section G2407 Combustion, Ventilation and Dilution Air; G2407.6.2 One-permanent-opening method.

**Note:** Combustion air openings must be located away from combustion air exhaust vents if there is a power vented appliance along with a standard draft hood appliance.

NOTES: Openings to outside shall be located within 12" of top of enclosure. The "top of the enclosure" refers to the ceiling of the room the appliances are located within. The net free areas must take into account louvers and grilles if they are installed. Assume 75% free area for metal and 25% for wood if the specific louver/grille dimensions are unknown.

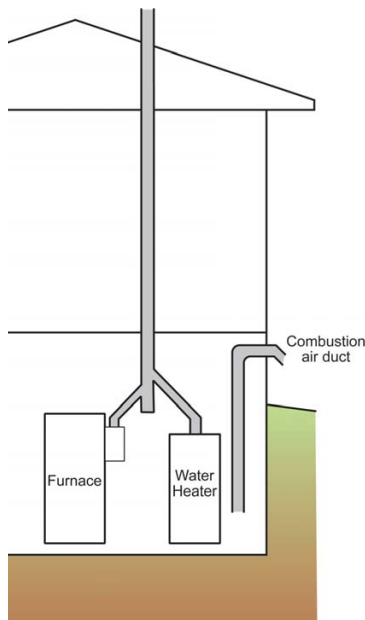

**Basement Wall  
Combustion Air Supply**

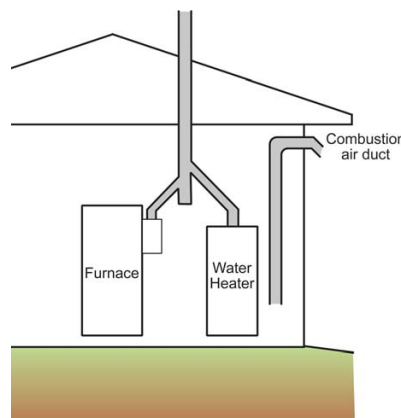

**Exterior Wall  
Combustion Air Supply**

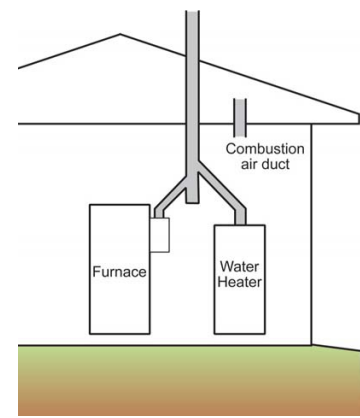

**Attic Ceiling  
Combustion Air Supply**

### Clothes Dryers: Gas and Electric

Clothes dryers are powerful exhaust devices that typically exhaust 150 cfm of interior air to the outside. A make-up air opening of 100 square inches is necessary for gas dryers and is recommended for electric dryers where dryers are located in rooms or closets.

Where gas clothes dryers are located in the same space as gas furnaces and water heaters the Btu input of the gas clothes dryer should be added to the Btu input of natural draft gas-fired furnaces and natural draft gas-fired water heaters when sizing the duct supplying outside combustion air using TABLE 1 (above).

**Reference** – 2006 International Residential Code, Section G2439.4, and 2006 International Fuel Gas Code, Section 614.5.

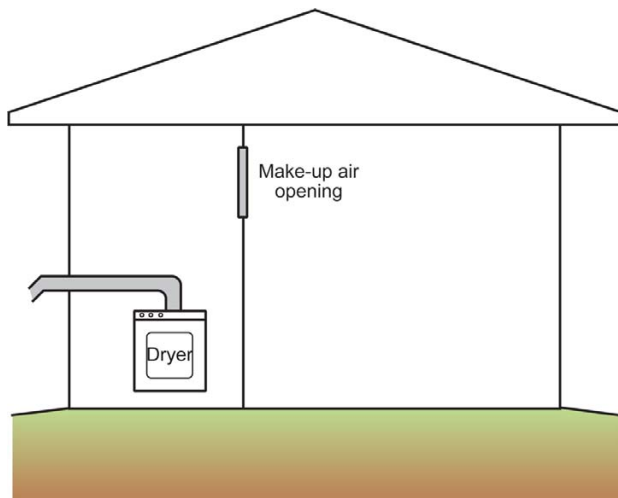

**Clothes Dryer Make-Up Air**

### Test Effectiveness of Combustion Air Supply

The effectiveness of the method of supplying combustion air should be determined by the procedure contained in Appendix D of the 2009 International Fuel Gas Code. Chimney draft is checked with all exhaust appliances such as dryers, kitchen fans and bathroom fans operating and also with the air handling unit fan(s) operating and interior doors closed.

**Reference** – 2009 International Fuel Gas Code; Appendix D: Recommended Procedure for Safety Inspection of an Existing Appliance Installation.

### If the House has Oil-fired Appliances . . .

Oil-fired furnaces, boilers and water heaters that have natural draft chimneys require combustion air. It should be supplied from the outside by a duct. If these ducts are not sized correctly or if they are blocked this can result in incomplete combustion of the fuel and can lead to backdrafting. Backdrafting occurs when hazardous exhaust gasses enter into the house rather than exit through the flue. The requirements for gas appliances are slightly different than those for oil appliances. Houses with appliances with natural draft chimneys, even if combustion air is supplied directly from the outside, should be tested for backdrafting.

Additionally, if the house has combustion appliances, carbon monoxide detectors complying with UL 2034 are required in close proximity to the combustion appliances and outside each separate sleeping area in the immediate vicinity of the bedrooms.

### Provide Combustion Air for Oil Appliances

A duct supplying outside combustion air is required for all natural draft oil-fired furnaces and natural draft oil-fired water heaters. The size of this duct is determined by the sum of the Btu input into both appliances and TABLE 2 (below). In addition, for oil burning appliances, two additional openings to the inside are required if the oil burning appliances are enclosed in a room. The size of these two openings can also be found in TABLE 2. If the oil burning appliances are not contained in a separate room then these two openings to the interior are not required. For example, if an oil-fired furnace and oil-fired water heater are located in an open basement then no additional openings to the interior are required.

**Combustion safety** – for more information, see: [www.cpsc.gov/cpsc/pub/pubs/452.html](http://www.cpsc.gov/cpsc/pub/pubs/452.html) and [www.epa.gov/iaq/homes/hip-combustion.html](http://www.epa.gov/iaq/homes/hip-combustion.html)

**Reference** – 2009 International Fuel Gas Code; Appendix D: Recommended Procedure for Safety Inspection of an Existing Appliance Installation.

**Reference** – 2009 International Residential Code For One- and Two-Family Dwellings: Chapter 3 - Building Planning; Section R315 Carbon Monoxide Alarms.

**Note** – Homes may have more than one combustion air zone. In other words, combustion appliances may be located in more than one part of a house - in different areas. Each zone needs to be treated separately.



**TABLE 2: Oil-fired Appliances – SINGLE OPENING TO OUTSIDE AND TWO OPENINGS TO THE INSIDE**

Total input rating of all Appliances in space (Btu)		One Exterior Opening		Two Interior Openings
from	to	Free Area (sq in)	Duct Diameter (in)	Free Area of Each Opening (sq in)
0	39,999	7	3	40
40,000	64,999	13	4	65
65,000	99,999	20	5	100
100,000	144,999	28	6	145
145,000	194,999	38	7	195
195,000	254,999	50	8	255
255,000	319,999	64	9	320
320,000	394,999	79	10	395

**Reference** – Oil Appliances: NFPA 31, Standard for the Installation of Oil-Burning Equipment, 2006 Edition; Chapter 5 Air for Combustion and Ventilation.

*Single opening to outdoors, appliances in unconfined spaces:* 5.3 Appliances Located in Unconfined Spaces; Paragraph 5.3.2.

*Single opening to outdoor, appliances in confined spaces:* 5.4.3 Ventilation Air Taken from Inside the Building - Combustion Air Taken from Outdoors.

*Openings to indoors sized by:* 5.4.1 All Air Taken from Inside the Building; Paragraphs 5.4.1.1 and 5.4.1.2.

**Note:** Combustion air openings must be located away from combustion air exhaust vents if there is a power vented appliance along with a standard draft hood appliance.

NOTES: The net free areas must take into account louvers and grilles if they are installed. Assume 75% free area for metal and 25% for wood if the specific louver/grille dimensions are unknown

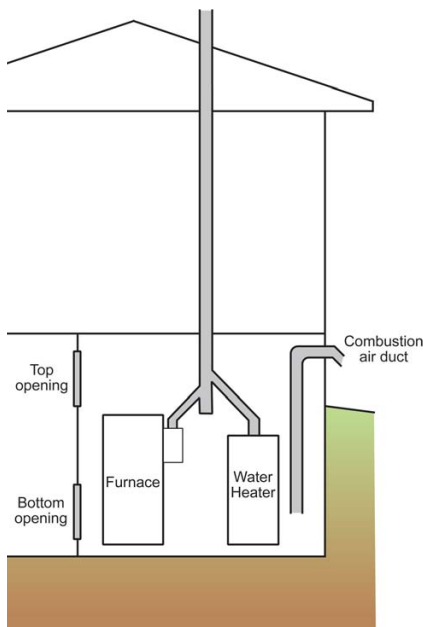

**Basement Wall Combustion Air Supply**

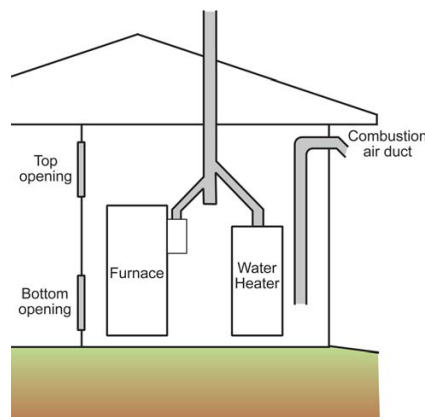

**Exterior Wall Combustion Air Supply**

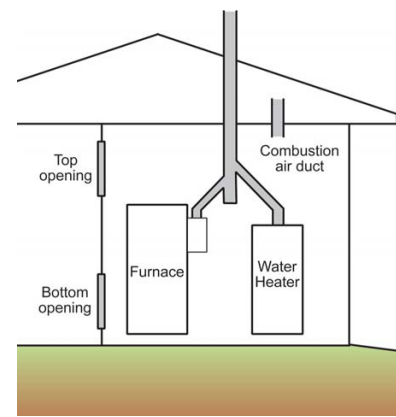

**Attic Ceiling Combustion Air Supply**

**Test Effectiveness of Combustion Air Supply**

The effectiveness of the method of supplying combustion air should be determined by the procedure contained in Appendix D of the 2009 International Fuel Gas Code. Chimney draft is checked with all exhaust appliances such as dryers, kitchen fans and bathroom fans operating and also with the air handling unit fan(s) operating and interior doors closed.

**Reference** – Appendix D – Recommended Procedure for Safety Inspection of an Existing Appliance Installation; 2009 International Fuel Gas Code.

**Indoor Air Quality – Controlled ventilation**

All houses require small amounts of controlled mechanical ventilation. This can be accomplished with an exhaust system, a supply system or a balanced system.

For ventilation systems to ventilate they must be run. Continuous operation of a ventilation system typically controls indoor contaminants more effectively than infrequent operation. Proper sizing is important (see sidebar definition and example). Under sizing and infrequent operation can lead to elevated levels of indoor contaminants. Over sizing can lead to excessive energy consumption and elevated levels of interior moisture in humid climates. Over sized ventilation systems that run continuously should be avoided.

A properly-sized bathroom fan that is vented to the exterior that is controlled by a timer or operated continuously is one of the acceptable options for an acceptable exhaust system.

**Reference** – ASHRAE Standard 62.2 – 2010: Ventilation and Acceptable Indoor Air Quality in Low Rise Residential Buildings

**Note:** Excessive ventilation in humid climates is not recommended as it can lead to elevated interior levels of moisture.

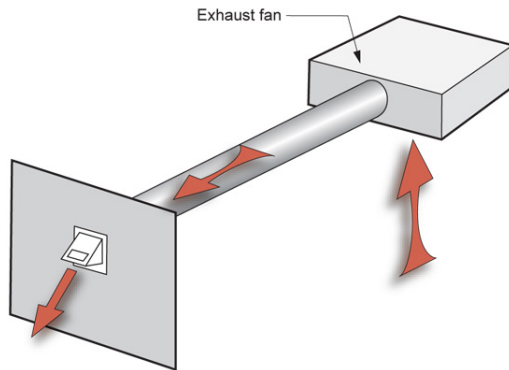

**Exhaust System**

An acceptable supply system is a properly-sized outside air duct connected to the furnace or air conditioner. The outside air duct requires a volume damper and a motorized damper and controller to prevent over-ventilation and under-ventilation.

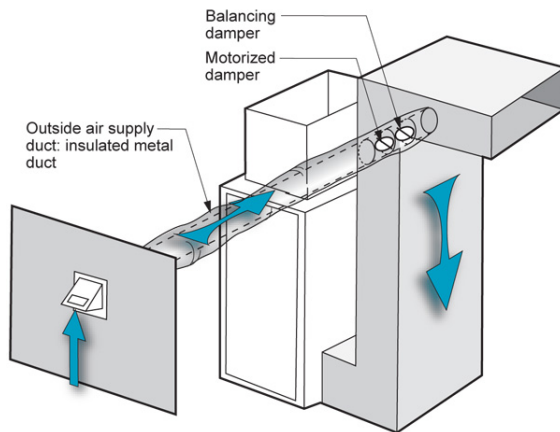

**Supply System**

**Definition – Mechanical ventilation flow rates** (exhaust or supply) are determined as follows:

- Flow Rate = Occupant Rate + Building Rate
- Occupant Rate = (no. of bedrooms + 1) x 7.5 cfm
- Building Rate = Occupied Floor Area x 0.01 cfm

**Example:** A three-bedroom house with a floor area of 2,000 ft<sup>2</sup> requires a mechanical ventilation flow rate of 50 cfm

- Occupant Rate = (3 + 1) x 7.5 = 30 cfm
- Building Rate = 2,000 x 0.01 = 20 cfm
- Flow Rate = 30 + 20 = 50 cfm

**Definition – Volume Damper:** A volume damper or a balancing damper is a device that adjusts flow rate – a flap or iris that can be closed off to reduce flow – or opened up to increase flow. These types of dampers are usually set once manually.

**Definition – Motorized Damper:** A motorized damper is a device that opens and closes via an electronic control such as a timer or thermostat or ventilation stat or humidistat. The damper should also be tied to compressor operation.

An acceptable balanced system is a properly-sized air-to-air heat exchanger/heat recovery ventilator or an energy recovery ventilator that both exhausts inside air to the exterior and supplies outside air to the interior at approximately the same rate. Such systems are typically designed to operate on a timer or continuously.

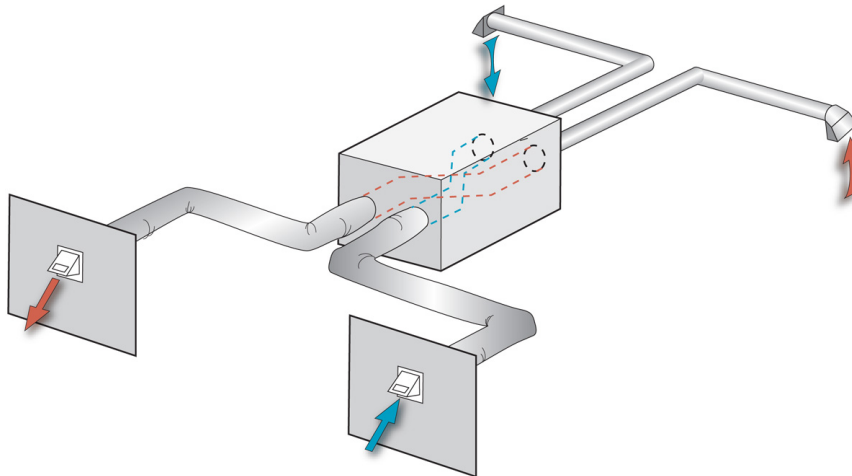

**Balanced System**

Another acceptable exhaust system is a properly-sized multipoint exhaust system that is vented to the exterior. Such systems are typically designed to operate on a timer or continuously.

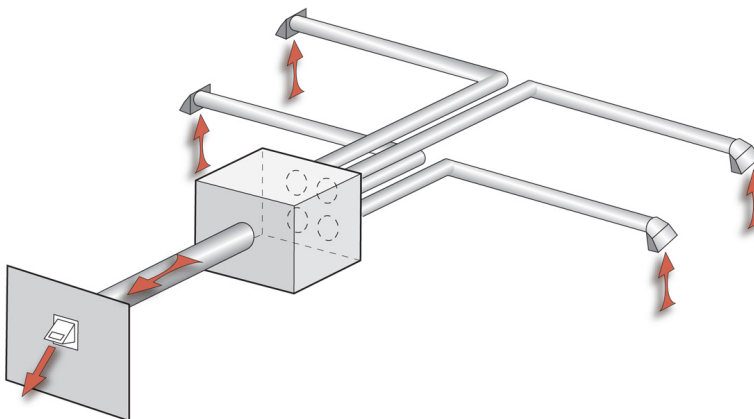

**Multipoint Exhaust System**

**Note:** Air-to-air heat exchangers or heat recovery ventilators (HRV's) are recommended for cold climates and dry climates.

Energy recovery ventilators (ERV's) are recommended for humid climates.

**Note:** A typical configuration for a multipoint exhaust system involves exhausting from bathroom and wet areas.

**Attic Ventilation with Soffit Vents**

Attic ventilation is an important factor in controlling moisture in roof sheathing and structural members in most types of housing. It therefore significantly impacts the durability of the typical house. All roofs must be vented according to the applicable building code. If the roof is not vented according to the applicable building code then a qualified contractor in the State should be engaged to install the necessary venting.

For attic ventilation to be effective outside air should enter the attic low at the attic perimeter and exit high near the attic ridge – intake air inlets down low – exhaust air outlets up high.

It is important to provide an air gap at the soffit/eave area to control the accumulation of moisture at the roof sheathing over the soffit/eave area. This air gap can be used with soffit vents to provide the inlet for attic intake ventilation air. Continuous soffit vents work best and are recommended.

Various types of outlets (ridge vents, mushroom cap vents and upper gable end vents) can be matched with soffit inlets (see illustration below).

**Definition – Attic Ventilation:** The intentional flow of outdoor air into an attic space balanced by the intentional flow of attic air to the outside by natural means.

**Note:** House attics can be designed and constructed and renovated to be unvented. However, this requires specialized knowledge. Qualified individuals should be consulted when implementing this type of approach – and the respective sections of the applicable building code governing the construction of unvented attics be followed.

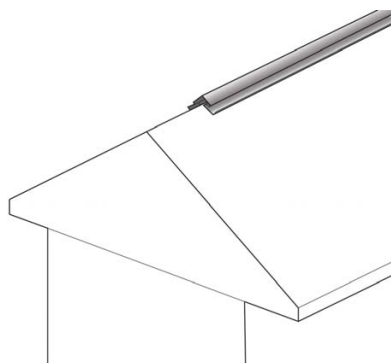

**Ridge Vent**

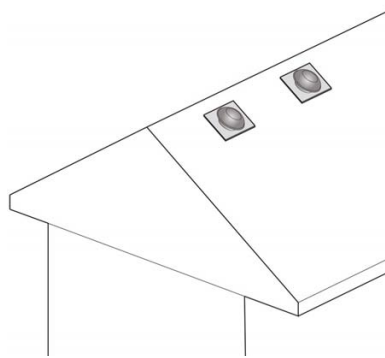

**Mushroom Cap Vent**

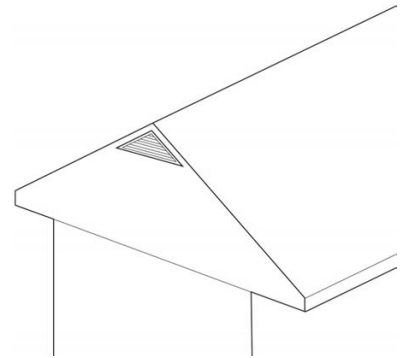

**Gable Vent**

The size of the vents should be determined by the applicable building code. Most codes require that roofs be vented where the net free ventilating area be not less than 1/300 of the area of the space to be ventilated – ideally with the vent area of the low inlet vents being equal to the vent area of the high outlet vents – in other words the vent area split equally high and low.

**Reference – Attic Ventilation:** 2009 International Residential Code for One- and Two-Family Dwellings; Chapter 8, Roof-Ceiling Construction; Section R806 Roof Ventilation; R806.2 Minimum area and R806.3 Vent and insulation clearance.

Soffit vents must be used in conjunction with ridge vents or mushroom cap vents or gable vents.

**Note:** If it is not possible to split the vent area equally between high and low – the low vents are more important. It is better to have a greater area of vents down low than vents located up high. Excessive vents up high can lead to suction in the attic resulting in the drawing of air out of the top of the house. Make-up air for attic ventilation should come from the outside not from the house.

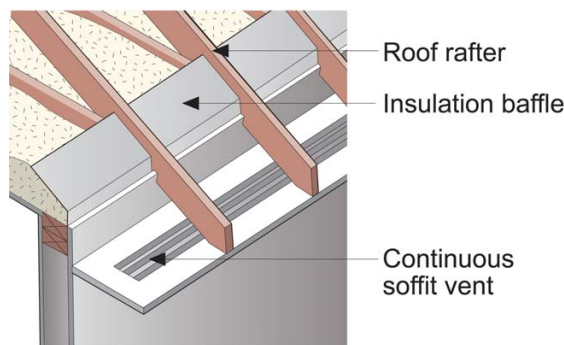

**Continuous Soffit Attic Ventilation – Insulation Baffles Required in Every Bay**

**Note:** Where radiant barriers are installed below a roof deck it is necessary to vent the attic space both above and below the radiant barrier (except where the radiant barrier is directly attached to the roof deck). In addition the radiant barrier must have openings at vent openings such as ridge vents or off-ridge vents. Radiant barriers need an adjacent airspace to function – 1” is the recommended minimum.

**Attic Ventilation without Soffit Vents**

Not all roofs can be vented with soffit vents providing the necessary inlet for attic intake ventilation air. Some roofs have minimal or non-existent overhangs or sufficient soffit area for soffit vent installation.

If soffit venting is not possible then an alternative method of providing intake air inlets low near the roof perimeter should be provided. Two recommended methods are low gable vents located near the attic ceiling (but above the top of the level of the attic ceiling insulation) and “eye-brow” vents that can be located on the top of the sloping roof surface near the soffit area/eave.

Even without soffit ventilation it is important to provide an air gap at the soffits/eave area to control the accumulation of moisture at the roof sheathing over the soffit/eave area.

Various types of outlets (ridge vents, mushroom cap vents and upper gable end vents) can be matched with low gable vents and “eye-brow” inlets (see illustrations below).

Homes without accommodation for ventilation openings at the soffit or eave, shall have a net free ventilating area of not less than 1/150 of the area of the ventilated attic/roof space.

**Reference** – Attic Ventilation: 2009 International Residential Code for One- and Two-Family Dwellings; Chapter 8, Roof-Ceiling Construction; Section R806 Roof Ventilation; R806.2 Minimum area and R806.3 Vent and insulation clearance.

**Note:** For attic ventilation to be effective outside air should enter the attic low at the attic perimeter and exit high near the attic ridge – intake air inlets down low – exhaust air outlets up high.

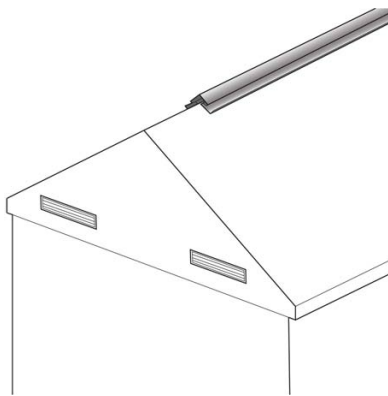

**Ridge Vent**

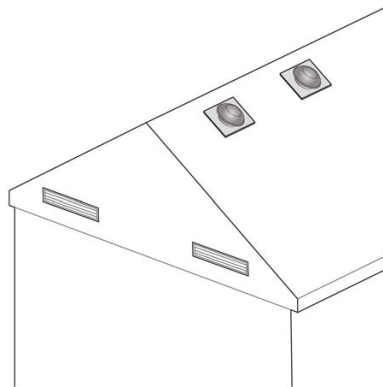

**Mushroom Cap Vent**

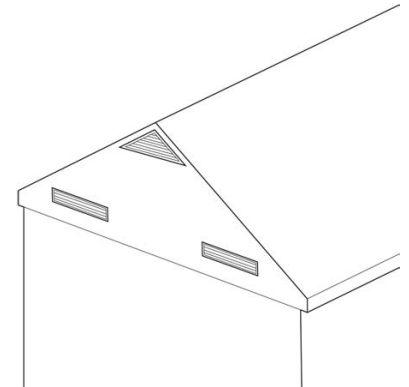

**Gable Vent**

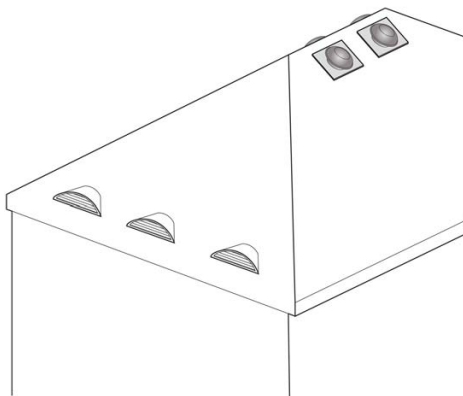

**Hip Roof with Eyebrow Vents**

The size of the vents should be determined by the applicable building code. Most codes require that roofs be vented where the net free ventilating area be not less than 1/300 of the area of the space to be ventilated – ideally with the vent area of the low inlet vents being equal to the vent area of the high outlet vents – in other words the vent area split equally high and low.

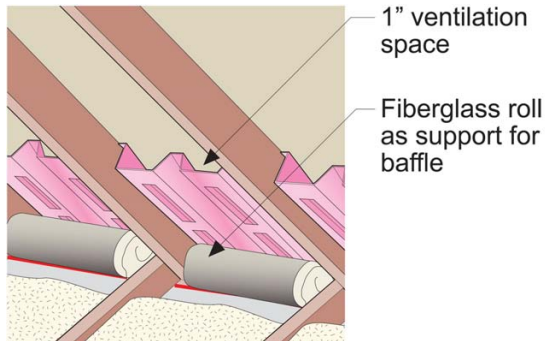

**Vent Baffle Supported by Fiber Glass Roll – Even When There Are No Soffit Vents**

The air gap provided by the vent baffle provides redistribution of moisture to the main body of the attic - even when there are no soffit vents. The vent baffle should be of plastic or of foam construction – cardboard vent baffles should be avoided where baffles are needed in unvented soffit/eave assemblies.

**Note:** If it is not possible to split the vent area equally between high and low – the low vents are more important. It is better to have a greater area of vents down low than vents located up high. Excessive vents up high can lead to suction in the attic resulting in the drawing of air out of the top of the house. Make-up air for attic ventilation should come from the outside not from the house.

### List of Attic Air Sealing Details

#### ATTIC ACCESS

- Attic Hatch, Access Panel
- Pull Down Stair Opening

#### FRAMING

- Balloon-framed Gable Wall
- Gable Truss
- Common Wall
- Dropped Soffits (bulkheads, arches, cabinet bonnets)
- Exterior Top Plate at Soffit
- Kneewalls
- Two Story Wall

#### MECHANICAL AND ELECTRICAL PENETRATIONS

- Bath Fan
- Chimney Chase – Masonry
- Chimney Chase – Metal Pipe
- Duct Boot
- Electrical Box
- Plumbing Stack
- Recessed Can Ceiling Light
- Rigid or Flex Duct and Chase
- Top Plate Joints and Penetrations (Electrical/Plumbing)

**Note:** There are some important openings that should not be sealed. Combustion air ducts and soffit, ridge and gable vents are all intentional openings that must be kept open to air movement in order to work properly.

## Sample Work Plan

### Inspection of the House

Before developing the work plan, complete an exterior walk-around, an interior walk-through, and an attic investigation. If any of the following items are found during the inspection they must be dealt with before proceeding with the retrofit.

- The house attic has active knob and tube wiring
- The house attic has vermiculite insulation
- The house has natural draft appliances
- The house attic has bathroom fans vented into the attic
- The house has a leaking roof

**1. Exterior:** As you complete the walk-around, note specifics such as size and location of the following items:

- Soffit Vents
- Gable End Vents
- Mushroom Vent Caps
- Plumbing Stacks
- Combustion Air Intakes and Exhausts
- Exhaust Air Vents

**2. Interior:** As you complete the walk-through, note specifics such as size and location of the following items:

- Attic Access and Type
- Dropped Soffits
- Exterior Wall Perimeter Length, Kneewalls
- Two Story walls
- Bath Fans in the ceiling
- Air Supply Vents through the ceiling
- Lighting fixtures in the ceiling, both recessed cans and standard lights
- Masonry and Metal Chimney pipe chases

Look for signs of a leaking roof. If the roof is leaking, it must be repaired before proceeding with the retrofit.

**3. Attic:** As you complete the attic investigation, note specifics such as size and location of the following items:

- Attic Access Type and Size
- Attic Vent Baffles and Exterior Top Plate
- Dropped Soffits open to the attic
- Kneewalls
- Top Plate Joints
- Two Story walls
- Mechanical, Electrical and Plumbing Penetrations
- Bath Fans and Venting
- Masonry and Metal Chimney pipe chases
- Ductwork

Look for signs of a leaking roof, active knob and tube wiring, vermiculite insulation or bathroom fans ducted into the attic or kneewall. If any one of these are found, they must be repaired before proceeding with the retrofit.



**Checklist and Work Plan**

**Stop-Work Items**

The house attic has active knob and tube wiring.  
 YES - The house must be rewired prior to the attic being air sealed and insulated.  
 NO - Proceed

The house attic has vermiculite insulation.  
 YES - The vermiculite insulation may contain asbestos and must be removed prior to the attic being air sealed and insulated. Professional advice should be obtained. Contact your State Department of Health.  
 NO - Proceed

The house attic has bathroom fans vented into the attic.  
 YES - Bathroom fans must be vented to the outside prior to the attic being air sealed and insulated.  
 NO - Proceed

The house has a leaking roof.  
 YES - The leaking roof must be fixed prior to the attic being air sealed and insulated.  
 NO - Proceed

---

**INTERIOR WALK THROUGH**

1 - Locate the mechanical space within the home. Find the information tags on each of the appropriate appliances. Record the following information:

Gas Furnace with Natural Draft Exhaust A = Btu Input <input type="text"/>	Oil Furnace with Natural Draft Exhaust E = Btu Input <input type="text"/>
Gas Water Heater with Natural Draft Exhaust B = Btu Input <input type="text"/>	Oil Water Heater with Natural Draft Exhaust F = Btu Input <input type="text"/>
Gas Boiler with Natural Draft Exhaust C = Btu Input <input type="text"/>	Oil Boiler with Natural Draft Exhaust G = Btu Input <input type="text"/>
Gas Fired Dryer D = Btu Input <input type="text"/>	

2 - Totalize all Natural Draft Appliance Input  
 Total Btu of All Gas Fired appliances in mechanical space Y = A+B+C+D   
 Total Btu of All Oil Fired appliances in mechanical space X = E+F+G   
 Total Btu of All Gas Fired appliances in mechanical space Z = X+ Y

3 - Check for Outdoor Combustion Air Supply Vent  
 If Combustion Air Supply Vent is Present  
 Diameter of Pipe   
 Number of Pipe (s) present   
 Pipe Material   
 Interior Location of Pipe   
 Outside location of Pipe and Height off of Ground   
 Compare Diameter and Total Btu present with Table 1 or Table 2 if Area on-site is equal to or greater than the area required  
 \*Always compare with Table 2 if any oil fired natural draft appliances are present

If Outdoor Combustion Air Supply Vent is Not Present or Undersized  
 A properly sized combustion Air Supply Vent must be Installed  
 Determine appropriate combustion air supply vent required from Table 1 and/or Table 2  
 Determine installation route for vent and approximate length required

4 - Check for Additional Indoor Air Vents if Oil Fired Natural Draft Appliances are Present and located in an Enclosed Space  
 If Indoor Air Vents are Present  
 Area of vents = A   
 Grill material - Wood (K = 0.25) or Metal (K = 0.75)  
 Effective Vent Area - EA = A x K Example - for a metal 100sqin vent - EA = 100 x 0.75 = 75 sqin   
 Compare this EA with the required effective area in Table 2.  
 If the area present does not meet the requirements of Table 2, additional venting area must be installed.

If Indoor Air Vents are Not Present or Undersized  
 Determine appropriate vent area required from Table 2  
 Determine installation location for vent(s)

5 - Check for Controlled Ventilation  
 Supply system - a properly sized outside air duct connected to the furnace or air conditioner  
 If a Supply system does not exist check for an exhaust system  
 Diameter of Pipe   
 Number of Pipe (s) present   
 Pipe Material   
 Location of Pipe   
 Outside location of Pipe and Height off of Ground   
 Damper Present and Functioning 

YES	NO
-----	----

Exhaust System  
 If an exhaust system or a supply system do not exist, one of either must be installed.  
 Number of Bathroom fans present   
 Bathroom fans exhaust to outdoors (Must be re-vented if vented into attics, kneewalls, conditioned crawlspaces, garages etc.)  
 Fans exhaust to unobstructed location 

YES	NO
-----	----

6 - Carbon Monoxide Detectors  
 Check for Operational Carbon monoxide detectors (test with test button) 

YES	NO
-----	----

  
 Check Location of Carbon Monoxide Detectors and ensure they are in close proximity to Natural Draft Appliances.  
 If Carbon Monoxide Detectors do not exist, are improperly located, or do not function properly a Carbon monoxide detector must be installed

CEILING AND ATTIC INVESTIGATION			
<p>1 - Attic Hatch</p> <p style="padding-left: 20px;">Approximate perimeter of opening <input style="width: 100px;" type="text"/></p> <p style="padding-left: 20px;">Approximate area of opening <input style="width: 100px;" type="text"/></p> <p>3 - Attic Vent Baffles and Exterior Top Plate</p> <p style="padding-left: 20px;">Approximate linear feet <input style="width: 100px;" type="text"/></p> <p>5 - Kneewalls</p> <p style="padding-left: 20px;">Approximate number of joist bays <input style="width: 100px;" type="text"/></p> <p style="padding-left: 20px;">Approximate knee wall area <input style="width: 100px;" type="text"/></p> <p>7 - Two Story Wall</p> <p style="padding-left: 20px;">Approximate number of joist bays or linear feet of interior wall <input style="width: 100px;" type="text"/></p> <p style="padding-left: 20px;">Approximate wall area <input style="width: 100px;" type="text"/></p> <p>9 - Bath Fan</p> <p style="padding-left: 20px;">Quantity, Make(s) and Model(s) <input style="width: 100px;" type="text"/></p> <p>11 - Masonry Chimney Chase</p> <p style="padding-left: 20px;">Quantity <input style="width: 100px;" type="text"/></p> <p style="padding-left: 20px;">Gap width to be covered <input style="width: 100px;" type="text"/></p> <p>13 - Electrical Box</p> <p style="padding-left: 20px;">Quantity <input style="width: 100px;" type="text"/></p> <p>15 - Recessed Can Ceiling Light</p> <p style="padding-left: 20px;">Quantity <input style="width: 100px;" type="text"/></p> <p style="padding-left: 20px;">Diameter <input style="width: 100px;" type="text"/></p> <p style="padding-left: 20px;">Height above Ceiling Drywall <input style="width: 100px;" type="text"/></p> <p>17 - Balloon Framed Gable</p> <p style="padding-left: 20px;">Approximate number of joist bays or linear feet of common wall <input style="width: 100px;" type="text"/></p>	<p>2 - Pull Down Stair Opening</p> <p style="padding-left: 20px;">Approximate perimeter of opening <input style="width: 100px;" type="text"/></p> <p style="padding-left: 20px;">Approximate area of opening <input style="width: 100px;" type="text"/></p> <p>4 - Dropped Soffits (bulkheads, arches)</p> <p style="padding-left: 20px;">Linear Feet <input style="width: 100px;" type="text"/></p> <p style="padding-left: 20px;">Depth/Width <input style="width: 100px;" type="text"/></p> <p>6 - Top Plate Joints</p> <p style="padding-left: 20px;">Approximate number of joist bays or linear feet of interior wall <input style="width: 100px;" type="text"/></p> <p>8 - Mechanical/Electrical Penetrations</p> <p style="padding-left: 20px;">Approximate number of penetrations <input style="width: 100px;" type="text"/></p> <p>10 - Metal Chimney Pipe Chase</p> <p style="padding-left: 20px;">Quantity <input style="width: 100px;" type="text"/></p> <p style="padding-left: 20px;">Gap width to be covered <input style="width: 100px;" type="text"/></p> <p>12 - Duct Boot</p> <p style="padding-left: 20px;">Quantity <input style="width: 100px;" type="text"/></p> <p style="padding-left: 20px;">Average Size <input style="width: 100px;" type="text"/></p> <p>14 - Plumbing Stack</p> <p style="padding-left: 20px;">Quantity <input style="width: 100px;" type="text"/></p> <p style="padding-left: 20px;">Diameter <input style="width: 100px;" type="text"/></p> <p>16 - Common Wall</p> <p style="padding-left: 20px;">Approximate number of joist bays or linear feet of common wall <input style="width: 100px;" type="text"/></p> <p>18 - Supply or Return Ducts</p> <p style="padding-left: 20px;">Quantity <input style="width: 100px;" type="text"/></p> <p style="padding-left: 20px;">Diameter <input style="width: 100px;" type="text"/></p>		
EXTERIOR WALK AROUND			
<p>Attic ventilation</p> <p style="padding-left: 40px;">If soffits vents and one of Gable end vents, ridge vents or mushroom caps are not present, attic ventilation must be installed prior to air sealing and insulating.</p>			
<p>1 - Lower Vent Area - Soffit Vents</p> <p style="padding-left: 20px;">Length (paced on ground or measured for all sides) = L <input style="width: 100px;" type="text"/></p> <p style="padding-left: 20px;">Width (approximated from brick widths, overhang estimate or measured) = W <input style="width: 100px;" type="text"/></p> <p style="padding-left: 20px;">Total Soffit Area TSA = L x W <input style="width: 100px;" type="text"/></p>			
<p>2 - Higher Vent Area</p> <p>Gable End Vents - Rectangular or Square</p> <p style="padding-left: 20px;">Length (Estimated or measured) = L <input style="width: 100px;" type="text"/></p> <p style="padding-left: 20px;">Width (Estimated or measured) = W <input style="width: 100px;" type="text"/></p> <p style="padding-left: 20px;">Total Rectangular Area TRA = L x W <input style="width: 100px;" type="text"/></p> <p>Mushroom Vent Caps</p> <p style="padding-left: 20px;">Quantity Present <input style="width: 100px;" type="text"/></p> <p style="padding-left: 20px;">TMA = Total Present x Free Area Per Cap <input style="width: 100px;" type="text"/></p> <p>Total Higher Vent Area = TRA + TTA + TMA + TRVA <input style="width: 100px;" type="text"/></p>			
<p>3 - Total Higher Vent Area should equal or exceed the amount of Total Lower Vent Area provided at the soffit (TSA)</p> <p style="padding-left: 40px;">The sum of these areas should be at least equal to the 1/300 (or 1/150) rules discussed in detail in the Attic Air Sealing Guide - Appendix B.</p> <p style="padding-left: 40px;">Ideally the vent area should be split between high and low.</p>			
<p>4 - Take note of the following. Measure where appropriate</p> <p style="padding-left: 20px;">Location and size of plumbing stacks</p> <p style="padding-left: 20px;">Location and size of possible combustion air supply vents</p> <p style="padding-left: 20px;">Location of possible exhaust air vents</p>			
Checklist Verification			
<p>Upon completion of this checklist verify that you have made provisions for:</p>			
<p>Combustion air for Combustion Safety</p> <p style="padding-left: 20px;">If you have gas or oil fired furnaces or gas or oil fired water heaters that have natural draft chimneys combustion air supplied directly from the outside is required. Install carbon monoxide detectors.</p>			
<p style="padding-left: 40px;">Air Supply Present and Adequately Sized <input style="width: 100px;" type="text"/></p>	<p style="padding-left: 40px;">Air Supply System Must be Installed <input style="width: 100px;" type="text"/></p>		
<p>Controlled ventilation for indoor Air Quality</p> <p style="padding-left: 20px;">As a minimum houses require an exhaust fan or an outside air supply duct connected to the furnace or air conditioner.</p>			
<p style="padding-left: 40px;">Controlled Ventilation Present <input style="width: 100px;" type="text"/></p>	<p style="padding-left: 40px;">Controlled Ventilation Must be Installed <input style="width: 100px;" type="text"/></p>		
<p>Attic Ventilation for Durability</p> <p style="padding-left: 20px;">All roofs must have soffit vents and be vented according to the applicable building code.</p>			
<p style="padding-left: 40px;">Attic Venting Present and Adequately Sized <input style="width: 100px;" type="text"/></p>	<p style="padding-left: 40px;">Attic Venting System Must be Installed <input style="width: 100px;" type="text"/></p>		
<p>Air Sealing all penetrations to the attic space and additional insulation for energy efficiency.</p> <p style="padding-left: 20px;">Air sealing is to be completed as per the specifications in this document. Insulating is to be completed as per the manufacturers recommendations.</p> <p style="padding-left: 40px;">All penetrations reviewed, measured and quantified <input style="width: 100px;" type="text"/></p>			

### Customer Communication

Upon Completion of the Inspection and the Checklist, provide a statement of work to the Homeowner.

Report the findings of your inspection and describe the work required. Be sure to include any stop work items.

*Example: For this home we will require additional venting to the mechanical room, a new bathroom fan that will supply the required ventilation, air sealing of the attic including all penetrations present, and additional insulation placed once the air sealing is complete.*

If you are a qualified professional or have sub-contracted qualified professionals who are able to repair the stop-work items and to complete the job in full, inform the Homeowner that you will provide them with a quote to complete the work within a reasonable time period. If you do not have the capability to repair the stop-work items, inform the Homeowner that they will have to hire additional qualified professionals to complete the necessary tasks before you are able to complete your portion of the work.

Provide the Homeowner with a quote for the work that is to the best of your knowledge complete and contains all items that will require installation, repair or replacement. Be aware that while you are quoting the job that the Homeowner may have already had, or may plan to have another contractor also bidding on the job. If the Homeowner is presented with a much more thorough review of the home or an equal review of the home with a better quote, you may not be awarded the job. A complete and thorough review of the home with an accurate quote can help win the job. Provide this Guide and the completed checklist to the Homeowner.

Schedule the time required to complete with the Homeowner. The Homeowner may want to be present during the construction or have someone present to oversee the construction. Inform the Homeowner that the person present overseeing your work must be at least 18 years of age.

On completion of the work, remind the Homeowner that any future work on the house involving a combustion appliance or powerful exhaust fan (e.g., kitchen exhaust greater than 300 cfm) must be provided with adequate combustion air or make-up air according to the building code.

### IMPORTANT

The Federal Trade Commission's R-value Rule (16 CFR Part 460) specifies substantiation and disclosure requirements for thermal insulation products used in the residential market, and prohibits certain claims unless they are true. The primary disclosure required is the insulation product's "R-value." R-value is the numerical measure of the ability of an insulation product to restrict the flow of heat and, therefore, to reduce energy costs—the higher the R-value, the better the product's insulating ability. To assist consumers, the Rule requires sellers (including insulation manufacturers, professional installers, new home sellers, and retailers) to disclose the insulation product's R-value and related information, before retail sale, based on uniform, industry-adopted standards. This information enables consumers to evaluate how well a particular insulation product is likely to perform, to determine whether the cost of the insulation is justified, and to make meaningful, cost-benefit based purchasing decisions among competing products.

For more information, please see [www.ftc.gov/energy](http://www.ftc.gov/energy).

### Attic Ventilation

The total net free ventilating area should not be less than 1/300 of the area of the attic/roof space to be ventilated and ventilation openings should be located both high and low in the roof assembly. Lower ventilation openings should be provided in each rafter bay of the roof assembly. A minimum 1-inch space should be maintained between the insulation and the roof sheathing and between the insulation and any roof vent openings.

The area of the attic/roof space to be ventilated is the area of the floor or ceiling that separates the attic/roof space from conditioned space. Therefore, minimum total net free ventilation area for an attic/roof space is equal to the area of the floor or ceiling beneath the roof assembly divided by 300.

It is recommended that not more than 50 percent of the net free ventilating area be located high on the roof. These upper ventilation openings should be located at least 3 feet above the soffit or eave vent openings.

Homes without roof overhangs or other accommodation for ventilation openings at the soffit or eave, should have a net free ventilating area of not less than 1/150 of the area of the ventilated attic/roof space. Refer to the example for 1:150 attic ventilation below.

**Definition:** Net free ventilating area refers to the clear open area of a vent taking into account the restrictions of the vent screens and vent slots. For example most screened vents have a 60 percent free area.

**Note:** The area of the attic/roof space is the sloped ceiling area in situations such as where the ceilings are applied directly to the underside of the roof rafters and where the attic/roof space is within scissor trusses.

#### Example for 1:300 high/low attic ventilation

Consider a house that is 30 ft wide by 42 ft long. The top floor ceiling is flat in this example so the area of the attic space is equal to the area of the foot print of the house.

The area of the ventilated attic space is therefore:

$$30 \text{ ft} \times 42 \text{ ft} = 1260 \text{ ft}^2$$

The required total net free ventilation area is:

$$1260 \text{ ft}^2 / 300 = 4.2 \text{ ft}^2$$

Converting  $\text{ft}^2$  to  $\text{in}^2$ , the required total net free ventilation area yields:

$$4.2 \text{ ft}^2 \times 144 \text{ in}^2/\text{ft}^2 = 605 \text{ in}^2 \text{ (note that the required area is rounded up to the nearest inch)}$$

Approximately 50% of the total net free ventilating area should be located in the upper portion of the roof - at least 3 ft above the soffit or eave vents. The required net free ventilating area of the upper roof vents should be:

$$0.5 \times 605 \text{ in}^2 = 303 \text{ in}^2$$

The remainder of the required free ventilating area should be provided by soffit or eave vents so that the total required free ventilating area is achieved. It is important that the soffit or eave vents provide ventilation in each rafter bay.

**Example for 1:150 attic ventilation**

Considering the same 30 ft by 42 ft house only this time without soffit vents, eyebrow vents or low gable vents. If it is not possible to provide ventilation openings at the bottom of the roof assembly, then the required minimum free ventilating area is 1/150 of the area of the attic/roof space to be ventilated.

The area of the ventilated attic space is:

$$30 \text{ ft} \times 42 \text{ ft} = 1260 \text{ ft}^2$$

The required total net free ventilation area is:

$$1260 \text{ ft}^2 / 150 = 8.4 \text{ ft}^2$$

Converting  $\text{ft}^2$  to  $\text{in}^2$ , the required total net free ventilation area yields:

$$8.4 \text{ ft}^2 \times 144 \text{ in}^2/\text{ft}^2 = 1210 \text{ in}^2 \text{ (note that the required area is rounded up to the nearest inch)}$$

**Air Barrier (ABM)** Any rigid or semi rigid material that does not allow air to pass through it. Examples: gypsum board, plywood/OSB, foam board, duct board (with a facing flame spread rating of 25 or less), sheet metal or dimensional lumber.

Relevant Test Methods: ASTM E2178 and E283

**Fire Rated Sealant (FRS)** Any sealant that is UL listed for use in any details requiring an approved fire rated sealant. Example: Sealing sheet metal ABM to a chimney.

Relevant Test Method: ASTM 814

Required Certification: UL1479

**Insulation** Any material which significantly slows down or retards the flow or transfer of heat. Building insulation types are classified according to form (e.g., loose-fill, batt, flexible, rigid, reflective, and foamed-in-place) or material (fiber glass, rock and slag wool, organic fiber, foam plastic)

Relevant Test Methods: ASTM C177, ASTM C518, ASTM C976, CFR Title 16, Part 460

**Rigid Foam** Rigid board material that provides thermal resistance. Foam plastic such as EPS, XPS, and polyisocyanurate.

Relevant Test Methods: ASTM C177, ASTM C518, ASTM C976, ICC-ES AC12, CFR Title 16, Part 460

**Sealant** Any flexible product which when applied to the join of two or more materials will adhere and permanently seal the joint to the passage of air. Examples: caulk, foam, and mastic.

Relevant Test Method: Foam sealants - ASTM C1642

Relevant Test Method: Acrylic, silicone, and urethane caulk - ASTM C-920

Required Certification: Water based duct sealant - UL 181A-M, UL 181B-M

**Spray Foam** Relevant Test Methods: "ICC-ES AC377, ASTM E84 CFR Title 16, Part 460"

**Tape (for ducts)** Required Certification: UL-181

**Tape (for air sealing)** Relevant Test Methods: ASTM D3330, ASTM D882

**Weatherstripping** Relevant Test Methods: ASTM C509

**TASK** – Control air leakage at the attic access hatch.

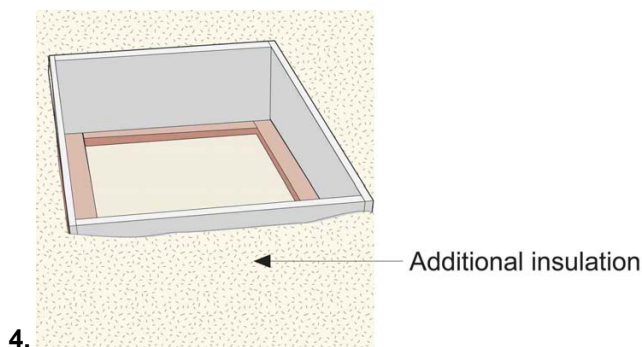
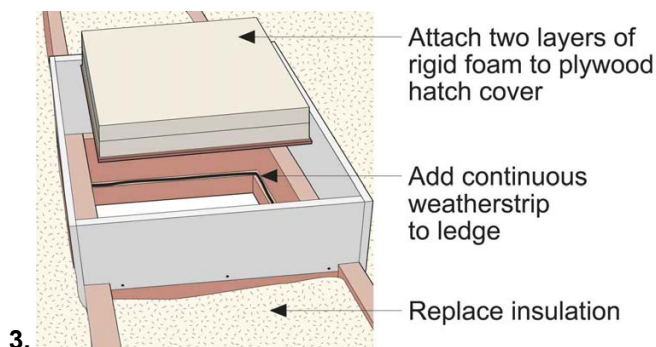
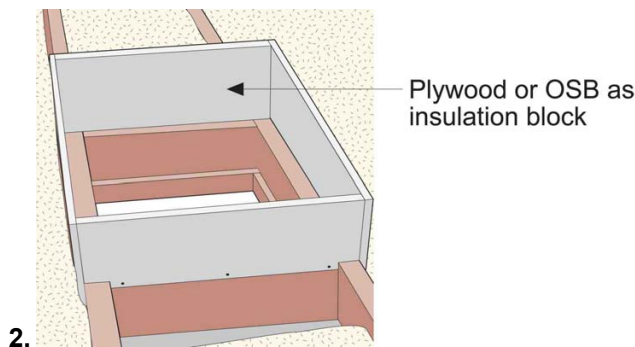
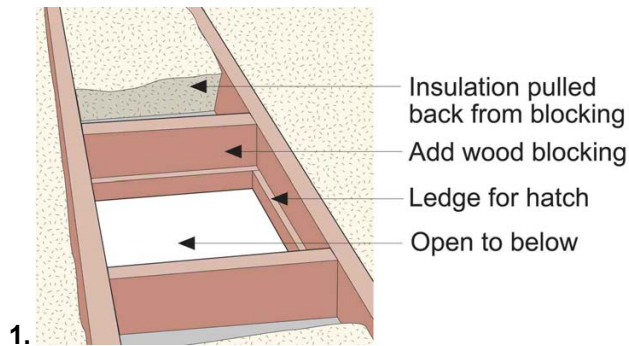

**Steps**

- Lift off and set aside attic access cover. [1]
- Cut and adhere two layers of rigid foam to access cover.
- Cut two cross pieces of framing lumber of equal height of ceiling joists to form a box around the access hole. [2]
- Mechanically Fasten wood cross pieces to joists.
- Apply an adhesive backed weather-stripping to the molding or ledge on which the cover will rest. [3]
- Cut and Fasten insulation Blocking material which will be at least 4 inches above the finished insulation level.

**Detail ready for insulation [4]**

**Terminology**

- Air Barrier Material (ABM)** --- Any rigid or semi rigid material that does not allow air to pass through it. Examples: gypsum board, plywood/OSB, foam board, duct board, sheet metal or dimensional lumber.
- Backing** --- Any material that serves as a surface to which foam can be sprayed so as to provide an air barrier. Examples: rolled up fiber glass batts.
- Baffle (B)** --- Manufactured chutes that create an insulation stop and direct ventilation air flow up and over the insulation; typically rigid foam board or cardboard.
- Thermal Blocking** --- Any rigid material that keeps insulation from heat sources like chimneys or recessed lights. Examples: sheet metal and gypsum board.
- Fasteners** --- Staples, screws or nails that are used to permanently attach Thermal Blocking or ABMs to framing.
- Sealant** --- Any flexible product which when applied to the join of two or more materials will adhere and permanently seal the joint to the passage of air. Examples: caulk, foam, and mastic.
- Fire Rated Sealant (FRS)** --- Any sealant that is UL listed for use in any details requiring an approved fire rated sealant. Example: Sealing sheet metal **ABM** to a chimney.

**TASK** – Control air leakage at the attic pull down stair opening.

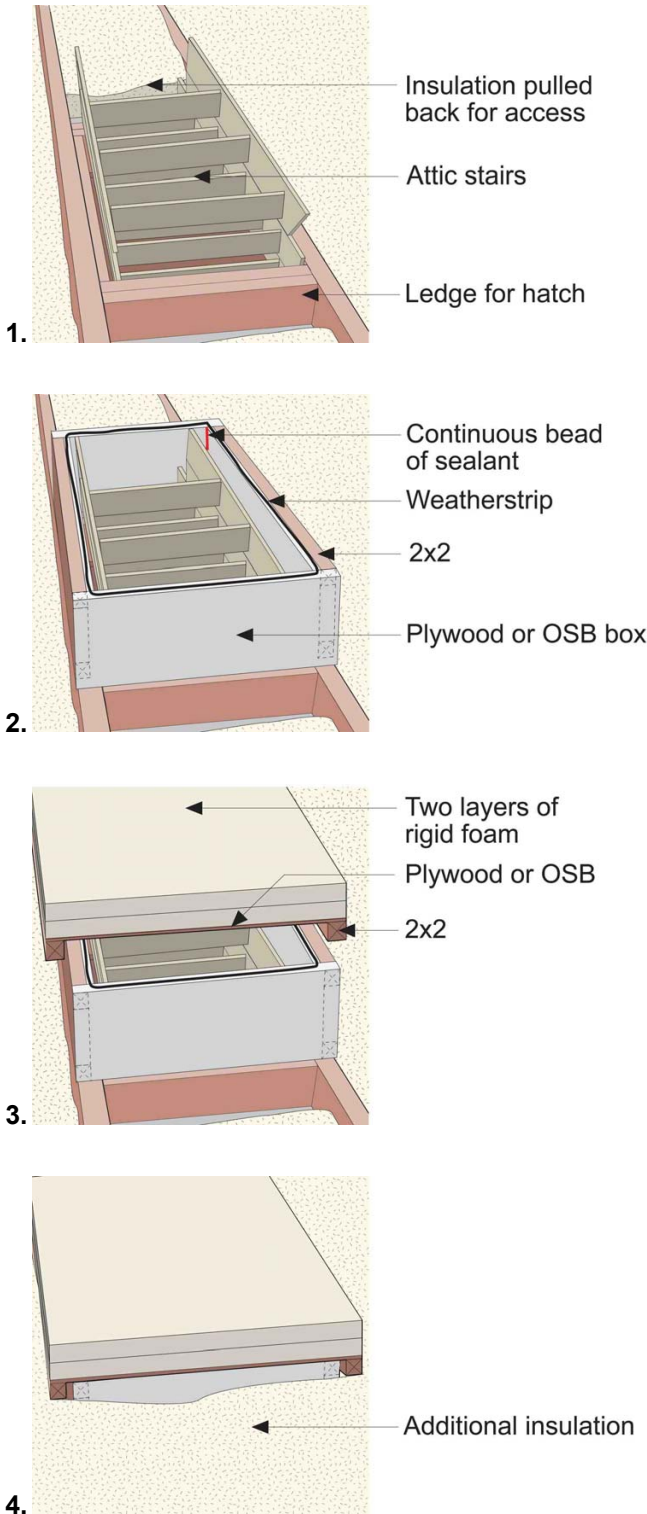

**Steps**

- Expose all framing around pull down stair opening. [1]
- Construct box opening to enclose pull down stairs. Top of box should extend 6 inches above top of finished insulation level.
- Fasten box opening to framing with **Fasteners**.
- Install a continuous bead of **Sealant** at the inside corners of the box opening and at the inside perimeter base of the box opening to the framing.
- Apply an adhesive backed weather-stripping to the ledge on which the cover will rest. [2]
- Construct a covering to the box opening.
- Cut and adhere two layers of rigid foam to the box opening cover. [3]

**Detail ready for insulation [4]**

**Terminology**

- Air Barrier Material (ABM)** --- Any rigid or semi rigid material that does not allow air to pass through it. Examples: gypsum board, plywood/OSB, foam board, duct board, sheet metal or dimensional lumber.
- Backing** --- Any material that serves as a surface to which foam can be sprayed so as to provide an air barrier. Examples: rolled up fiber glass batts.
- Baffle (B)** --- Manufactured chutes that create an insulation stop and direct ventilation air flow up and over the insulation; typically rigid foam board or cardboard.
- Thermal Blocking** --- Any rigid material that keeps insulation from heat sources like chimneys or recessed lights. Examples: sheet metal and gypsum board.
- Fasteners** --- Staples, screws or nails that are used to permanently attach Thermal Blocking or ABMs to framing.
- Sealant** --- Any flexible product which when applied to the joint of two or more materials will adhere and permanently seal the joint to the passage of air. Examples: caulk, foam, and mastic.
- Fire Rated Sealant (FRS)** --- Any sealant that is UL listed for use in any details requiring an approved fire rated sealant. Example: Sealing sheet metal **ABM** to a chimney.



**TASK** – Control air leakage where the gable wall meets the ceiling.

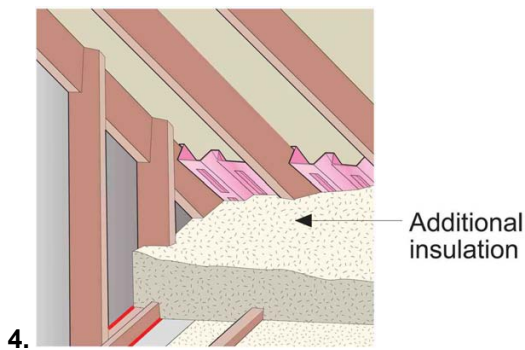
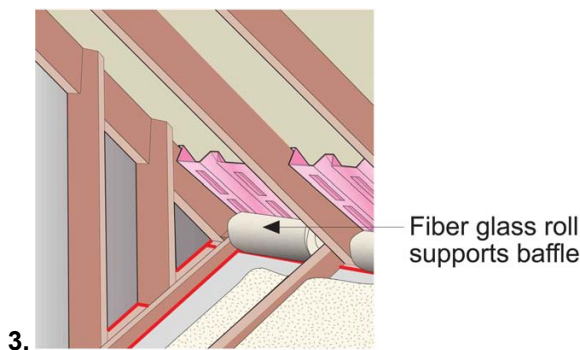
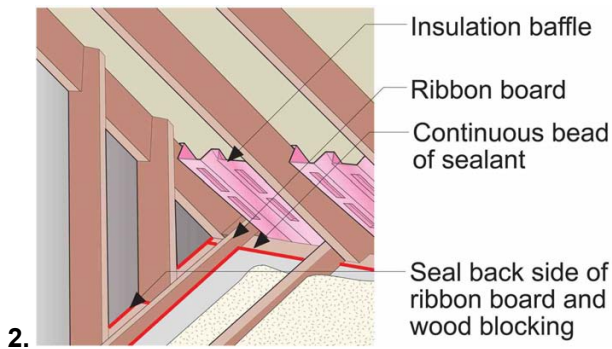
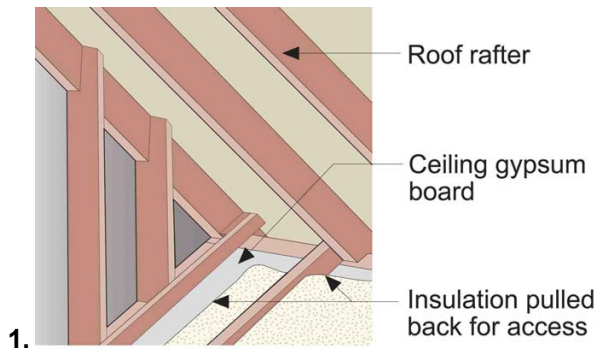

**Steps**

- Fully expose framing and ribbon board. [1]
- Seal all sides of wood blocking and back side of ribbon board with **Sealant**.
- Seal gypsum board/top plate joint with **Sealant**.
- Seal ribbon board/gypsum board joint with **Sealant**
- Install insulation baffle. [2]
- Install fiber glass batt insulation roll (or other suitable material) as support for baffle. [3]

**Detail ready for insulation [4]**

**Terminology**

**Air Barrier Material (ABM)** --- Any rigid or semi rigid material that does not allow air to pass through it. Examples: gypsum board, plywood/OSB, foam board, duct board, sheet metal or dimensional lumber.

**Backing** --- Any material that serves as a surface to which foam can be sprayed so as to provide an air barrier. Examples: rolled up fiber glass batts.

**Baffle (B)** --- Manufactured chutes that create an insulation stop and direct ventilation air flow up and over the insulation; typically rigid foam board or cardboard.

**Thermal Blocking** --- Any rigid material that keeps insulation from heat sources like chimneys or recessed lights. Examples: sheet metal and gypsum board.

**Fasteners** --- Staples, screws or nails that are used to permanently attach Thermal Blocking or ABMs to framing.

**Sealant** --- Any flexible product which when applied to the join of two or more materials will adhere and permanently seal the joint to the passage of air. Examples: caulk, foam, and mastic.

**Fire Rated Sealant (FRS)** --- Any sealant that is UL listed for use in any details requiring an approved fire rated sealant. Example: Sealing sheet metal **ABM** to a chimney.

**TASK** – Control air leakage where the gable wall meets the ceiling.

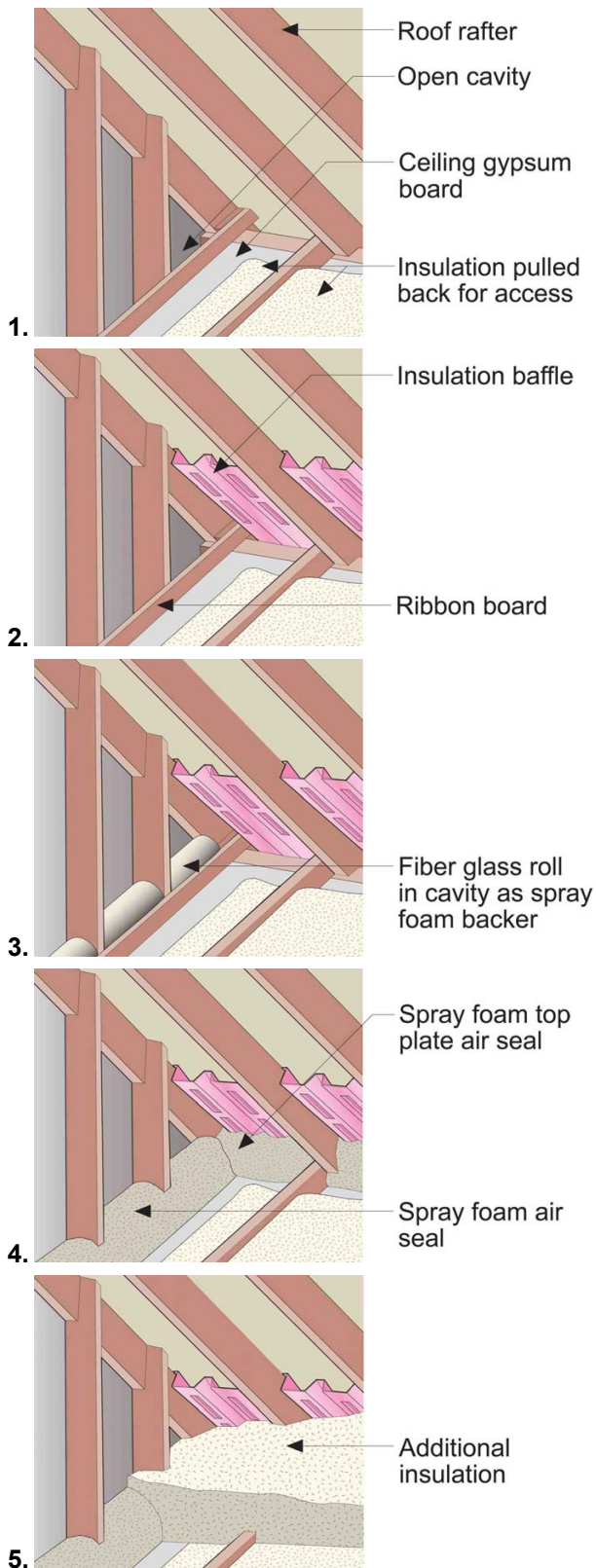

**Steps**

- Fully expose framing and ribbon board. [1]
- Install insulation baffle. [2]
- Roll up a fiber glass batt and friction fit it to fill the wall cavity to provide a backing for spray foam. [3]
- Use a foam pack, spray foam the perimeter top plate to the baffle completely covering the top plate extending 3 inches over the gypsum board. [4]
- Use a foam pack, spray foam full gable wall cavity completely covering the fiber glass roll and ribbon board extending 3 inches over the gypsum board. [4]

**Detail ready for insulation [5]**

**Terminology**

- Air Barrier Material (ABM)** --- Any rigid or semi rigid material that does not allow air to pass through it. Examples: gypsum board, plywood/OSB, foam board, duct board, sheet metal or dimensional lumber.
- Backing** --- Any material that serves as a surface to which foam can be sprayed so as to provide an air barrier. Examples: rolled up fiber glass batts.
- Baffle (B)** --- Manufactured chutes that create an insulation stop and direct ventilation air flow up and over the insulation; typically rigid foam board or cardboard.
- Thermal Blocking** --- Any rigid material that keeps insulation from heat sources like chimneys or recessed lights. Examples: sheet metal and gypsum board.
- Fasteners** --- Staples, screws or nails that are used to permanently attach Thermal Blocking or ABMs to framing.
- Sealant** --- Any flexible product which when applied to the join of two or more materials will adhere and permanently seal the joint to the passage of air. Examples: caulk, foam, and mastic.
- Fire Rated Sealant (FRS)** --- Any sealant that is UL listed for use in any details requiring an approved fire rated sealant. Example: Sealing sheet metal **ABM** to a chimney.

**TASK** – Control air leakage where the gable wall meets the ceiling.

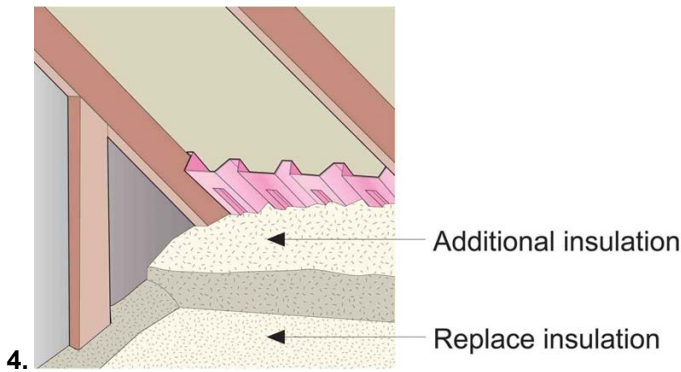
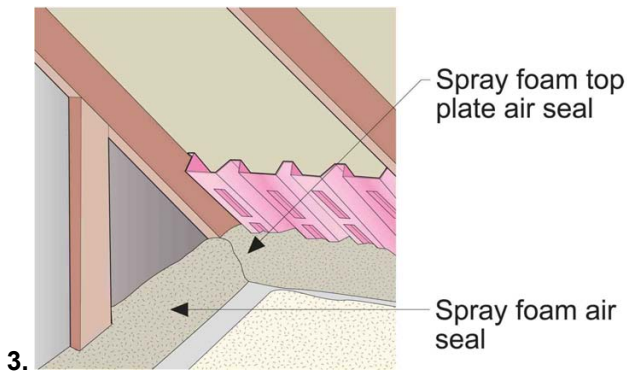
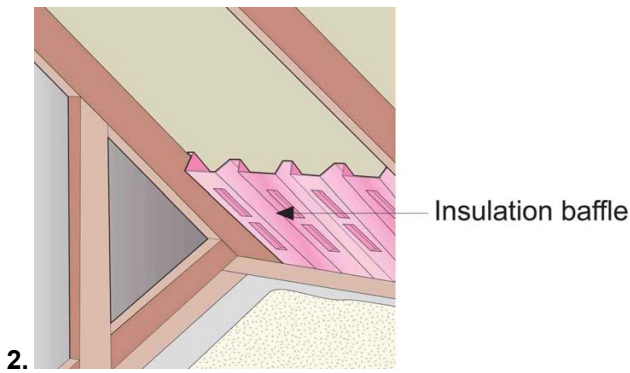
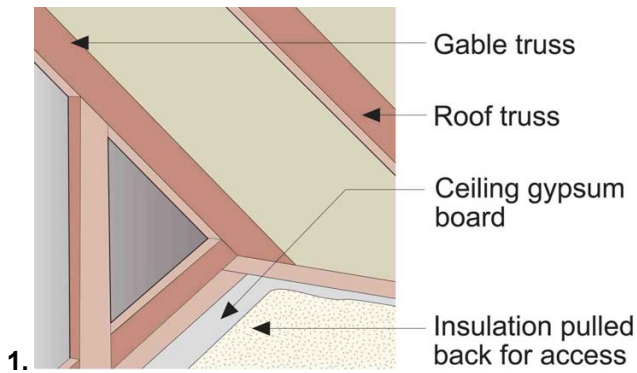

**Steps**

- Fully expose framing and bottom chord of gable truss. [1]
- Install insulation baffle. [2]
- Use a foam pack, spray foam perimeter top plate to the baffle completely covering the top plate extending 3 inches over the gypsum board. [3]
- Use a foam pack, spray foam bottom of gable truss and perimeter top plate extending 3 inches over the gypsum board. [3]

**Detail ready for insulation [4]**

**Terminology**

**Air Barrier Material (ABM)** --- Any rigid or semi rigid material that does not allow air to pass through it. Examples: gypsum board, plywood/OSB, foam board, duct board, sheet metal or dimensional lumber.

**Backing** --- Any material that serves as a surface to which foam can be sprayed so as to provide an air barrier. Examples: rolled up fiber glass batts.

**Baffle (B)** --- Manufactured chutes that create an insulation stop and direct ventilation air flow up and over the insulation; typically rigid foam board or cardboard.

**Thermal Blocking** --- Any rigid material that keeps insulation from heat sources like chimneys or recessed lights. Examples: sheet metal and gypsum board.

**Fasteners** --- Staples, screws or nails that are used to permanently attach Thermal Blocking or ABMs to framing.

**Sealant** --- Any flexible product which when applied to the joint of two or more materials will adhere and permanently seal the joint to the passage of air. Examples: caulk, foam, and mastic.

**Fire Rated Sealant (FRS)** --- Any sealant that is UL listed for use in any details requiring an approved fire rated sealant. Example: Sealing sheet metal **ABM** to a chimney.

**TASK** – Control air leakage at the common wall.

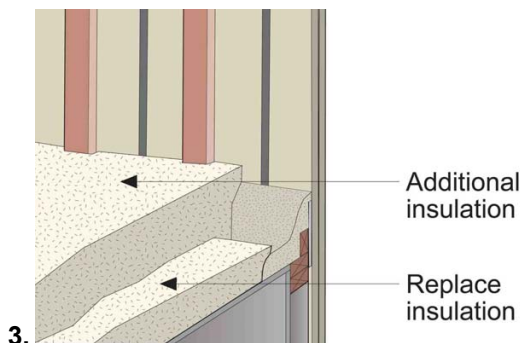
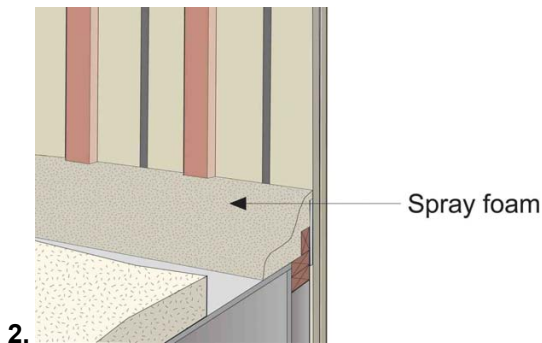
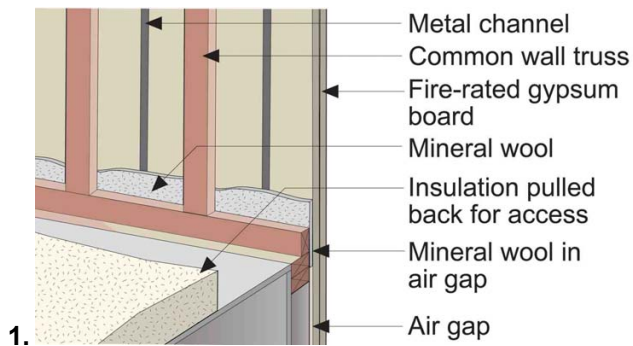

### Steps

- Fully expose framing and edge of ceiling gypsum board. [1]
- Use a foam pack, spray foam over the mineral firestop completely covering it, the bottom framing members extending three inches over the gypsum board. [2]

### Detail ready for insulation [3]

### Terminology

**Air Barrier Material (ABM)** --- Any rigid or semi rigid material that does not allow air to pass through it. Examples: gypsum board, plywood/OSB, foam board, duct board, sheet metal or dimensional lumber.

**Backing** --- Any material that serves as a surface to which foam can be sprayed so as to provide an air barrier. Examples: rolled up fiber glass batts.

**Baffle (B)** --- Manufactured chutes that create an insulation stop and direct ventilation air flow up and over the insulation; typically rigid foam board or cardboard.

**Thermal Blocking** --- Any rigid material that keeps insulation from heat sources like chimneys or recessed lights. Examples: sheet metal and gypsum board.

**Fasteners** --- Staples, screws or nails that are used to permanently attach Thermal Blocking or ABMs to framing.

**Sealant** --- Any flexible product which when applied to the join of two or more materials will adhere and permanently seal the joint to the passage of air. Examples: caulk, foam, and mastic.

**Fire Rated Sealant (FRS)** --- Any sealant that is UL listed for use in any details requiring an approved fire rated sealant. Example: Sealing sheet metal **ABM** to a chimney.

**TASK** – Control air leakage between the conditioned space below and the unconditioned attic space above at dropped soffits.

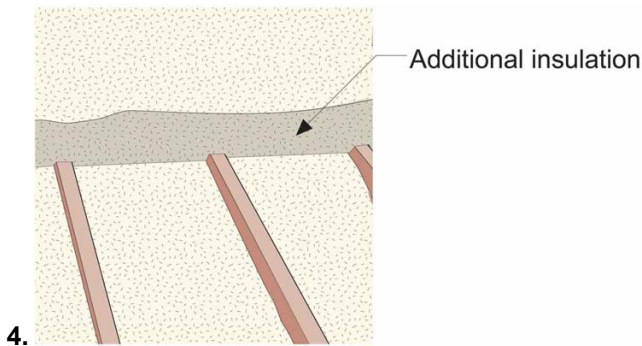
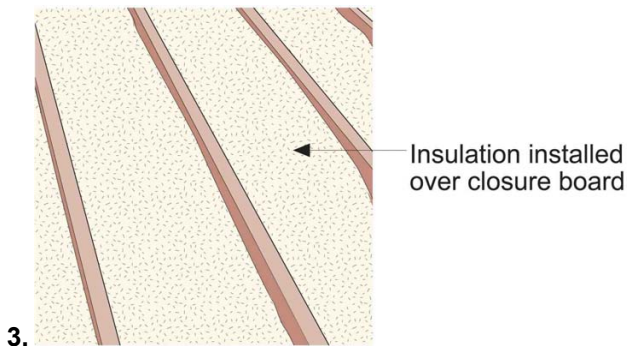
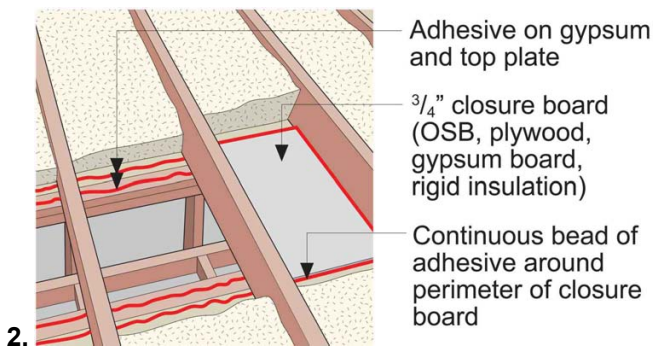
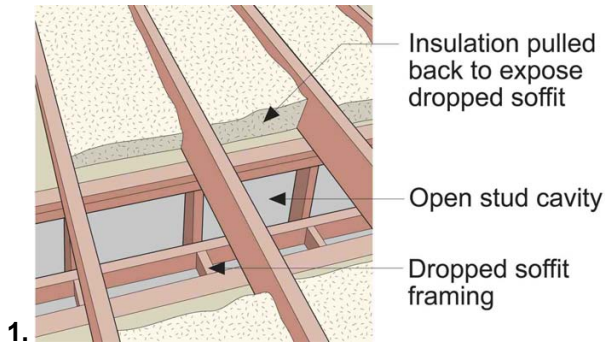

**Steps**

- Expose the dropped soffit including the framing [1].
- Measure and pre cut the **ABM** to be used to cover the drop or opening in the ceiling.
- Fix in place the **ABM** using adhesive or **Fasteners**.
- Air seal all edges of **ABM** to framing using **Sealant** [2].

**Detail ready for insulation** [3,4]

**Terminology**

**Air Barrier Material (ABM)** --- Any rigid or semi rigid material that does not allow air to pass through it. Examples: gypsum board, plywood/OSB, foam board, duct board, sheet metal or dimensional lumber.

**Backing** --- Any material that serves as a surface to which foam can be sprayed so as to provide an air barrier. Examples: rolled up fiber glass batts.

**Baffle (B)** --- Manufactured chutes that create an insulation stop and direct ventilation air flow up and over the insulation; typically rigid foam board or cardboard.

**Thermal Blocking** --- Any rigid material that keeps insulation from heat sources like chimneys or recessed lights. Examples: sheet metal and gypsum board.

**Fasteners** --- Staples, screws or nails that are used to permanently attach Thermal Blocking or ABMs to framing.

**Sealant** --- Any flexible product which when applied to the join of two or more materials will adhere and permanently seal the joint to the passage of air. Examples: caulk, foam, and mastic.

**Fire Rated Sealant (FRS)** --- Any sealant that is UL listed for use in any details requiring an approved fire rated sealant. Example: Sealing sheet metal **ABM** to a chimney.

**TASK** – Control air leakage at top plate, provide insulation coverage of top plate, direct attic ventilation air.

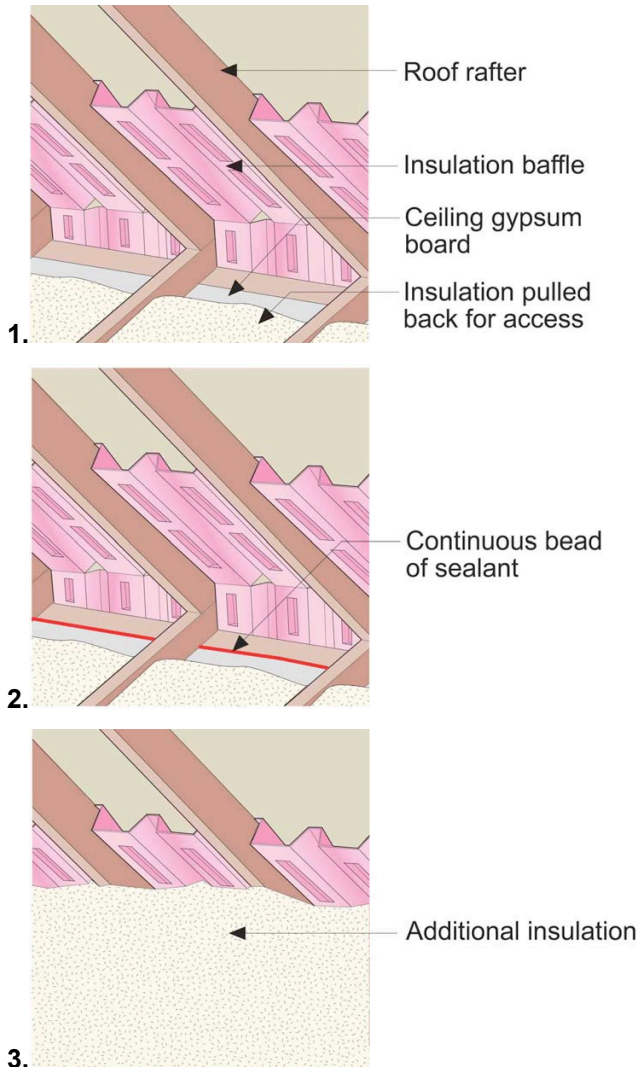

**Alternate Method**

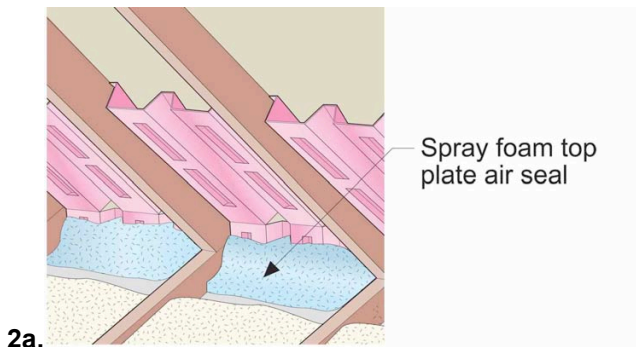

**Steps**

- Fully expose the top plate and fold or cut the **Baffle** to make a vertical backstop. [see below]
- Fix **Baffle** in place leaving the top plate fully exposed for maximum insulation. [1]
- Seal the gypsum board/top plate joint with **Sealant**. [2]

**Alternate Method**

- Fully expose the top plate and fold or cut the **Baffle** to make a vertical backstop. [see below]
- Fix **Baffle** in place leaving the top plate fully exposed for maximum insulation. [1]
- Using a foam pack, spray foam to backstop extending over gypsum board/top plate joint. Do not seal ventilation space behind insulation baffle.

**Detail ready for insulation [3]**

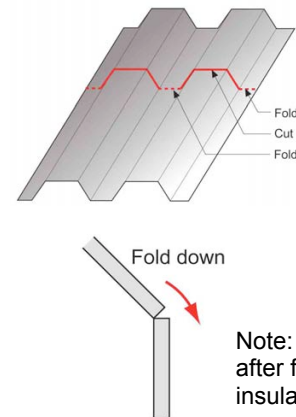

**Terminology**

- Air Barrier Material (ABM)** --- Any rigid or semi rigid material that does not allow air to pass through it. Examples: gypsum board, plywood/OSB, foam board, duct board, sheet metal or dimensional lumber.
- Backing** --- Any material that serves as a surface to which foam can be sprayed so as to provide an air barrier. Examples: rolled up fiber glass batts.
- Baffle (B)** --- Manufactured chutes that create an insulation stop and direct ventilation air flow up and over the insulation; typically rigid foam board or cardboard.
- Thermal Blocking** --- Any rigid material that keeps insulation from heat sources like chimneys or recessed lights. Examples: sheet metal and gypsum board.
- Fasteners** --- Staples, screws or nails that are used to permanently attach Thermal Blocking or ABMs to framing.
- Sealant** --- Any flexible product which when applied to the joint of two or more materials will adhere and permanently seal the joint to the passage of air. Examples: caulk, foam, and mastic.
- Fire Rated Sealant (FRS)** --- Any sealant that is UL listed for use in any details requiring an approved fire rated sealant. Example: Sealing sheet metal **ABM** to a chimney.

**TASK** – Control air leakage at top plate, provide insulation coverage of top plate, direct attic ventilation air.

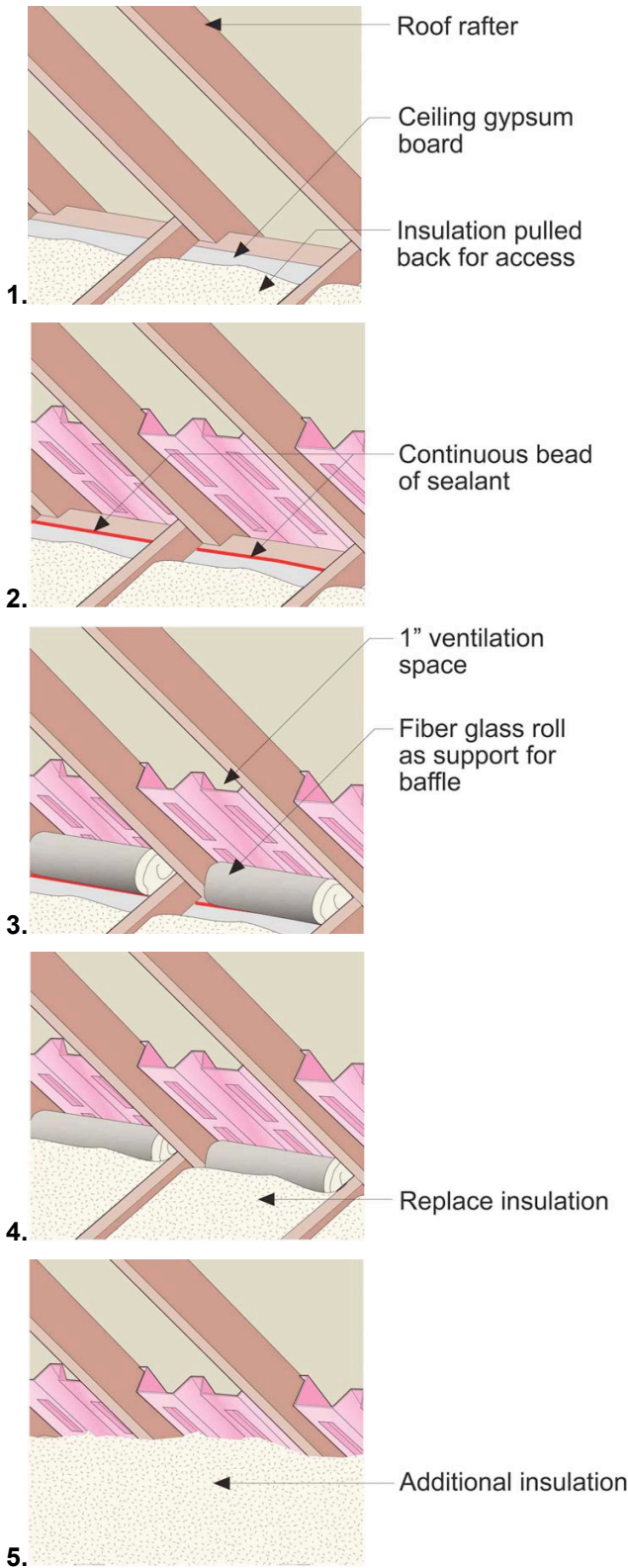

**Alternate Method**

- Fully expose the top plate and fold or cut the **Baffle** to make a vertical backstop.
- Fix **Baffle** in place leaving the top plate fully exposed for maximum insulation [1].
- Seal the gypsum board/top plate join with **Sealant**. [2]
- Install fiber glass batt insulation roll (or other suitable material) as support for baffle [3].

**Detail ready for insulation [4,5]**

**Terminology**

**Air Barrier Material (ABM)** --- Any rigid or semi rigid material that does not allow air to pass through it. Examples: gypsum board, plywood/OSB, foam board, duct board, sheet metal or dimensional lumber.

**Backing** --- Any material that serves as a surface to which foam can be sprayed so as to provide an air barrier. Examples: rolled up fiber glass batts.

**Baffle (B)** --- Manufactured chutes that create an insulation stop and direct ventilation air flow up and over the insulation; typically rigid foam board or cardboard.

**Thermal Blocking** --- Any rigid material that keeps insulation from heat sources like chimneys or recessed lights. Examples: sheet metal and gypsum board.

**Fasteners** --- Staples, screws or nails that are used to permanently attach Thermal Blocking or ABMs to framing.

**Sealant** --- Any flexible product which when applied to the joint of two or more materials will adhere and permanently seal the joint to the passage of air. Examples: caulk, foam, and mastic.

**Fire Rated Sealant (FRS)** --- Any sealant that is UL listed for use in any details requiring an approved fire rated sealant. Example: Sealing sheet metal **ABM** to a chimney.

**TASK** – Control air leakage between the conditioned floor space and unconditioned attic space.

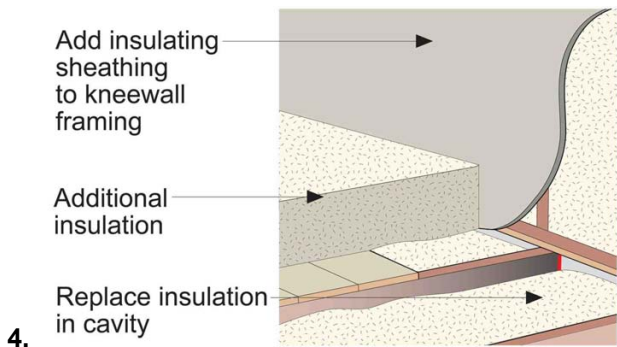
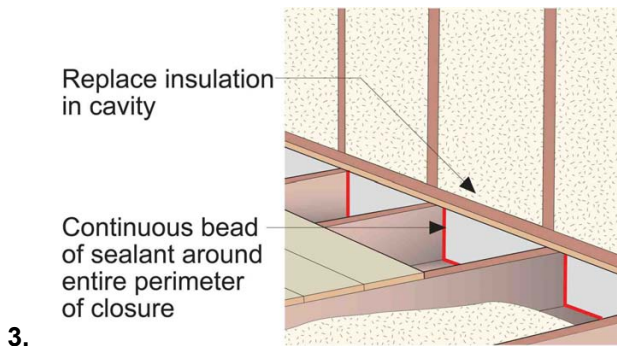
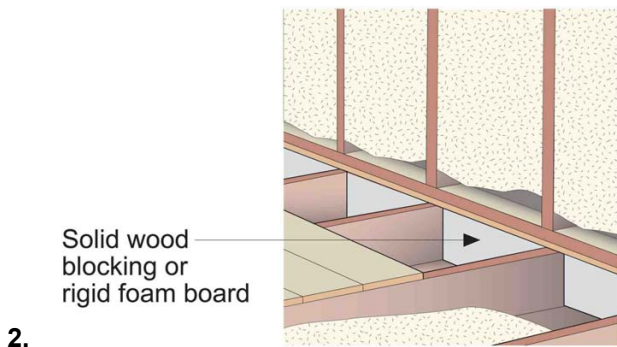
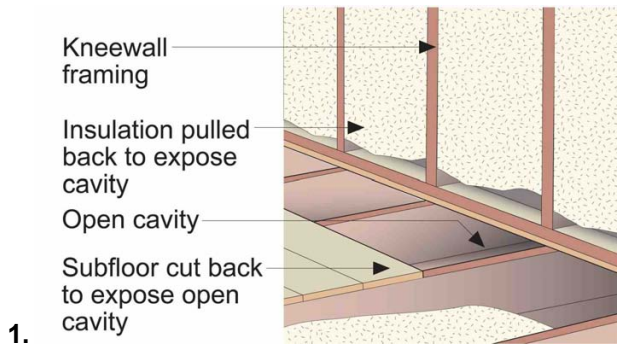

**Steps**

- Expose approximately an 18-inch attic joist area under the kneewall. [1]
- Cut and friction fit or Fasten **ABM** to span the joist cavity directly under the kneewall lining it up with the gypsum board of the conditioned room above. [2]
- Seal all edges of **ABM** with **Sealant** taking care to seal the hard to reach top edge. [3]
- Install insulating sheathing over kneewall framing. [4]

**Detail ready for insulation [4]**

**Terminology**

- Air Barrier Material (ABM)** --- Any rigid or semi rigid material that does not allow air to pass through it. Examples: gypsum board, plywood/OSB, foam board, duct board, sheet metal or dimensional lumber.
- Backing** --- Any material that serves as a surface to which foam can be sprayed so as to provide an air barrier. Examples: rolled up fiber glass batts.
- Baffle (B)** --- Manufactured chutes that create an insulation stop and direct ventilation air flow up and over the insulation; typically rigid foam board or cardboard.
- Thermal Blocking** --- Any rigid material that keeps insulation from heat sources like chimneys or recessed lights. Examples: sheet metal and gypsum board.
- Fasteners** --- Staples, screws or nails that are used to permanently attach Thermal Blocking or ABMs to framing.
- Sealant** --- Any flexible product which when applied to the join of two or more materials will adhere and permanently seal the joint to the passage of air. Examples: caulk, foam, and mastic.
- Fire Rated Sealant (FRS)** --- Any sealant that is UL listed for use in any details requiring an approved fire rated sealant. Example: Sealing sheet metal **ABM** to a chimney.



**TASK** – Control air leakage between the conditioned floor space and unconditioned attic space.

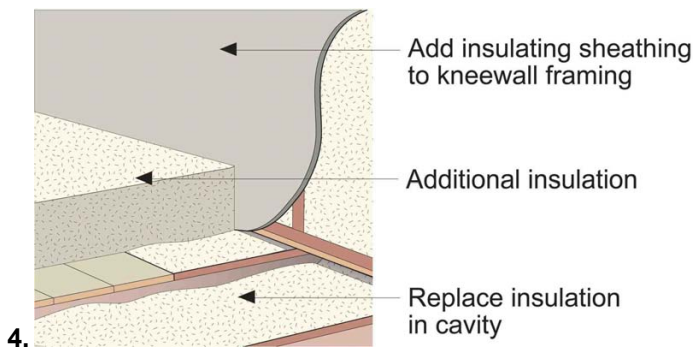
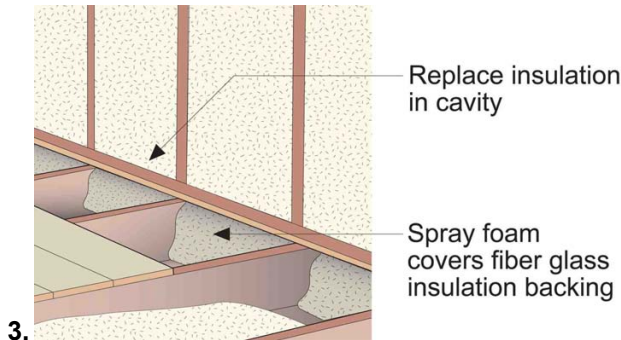
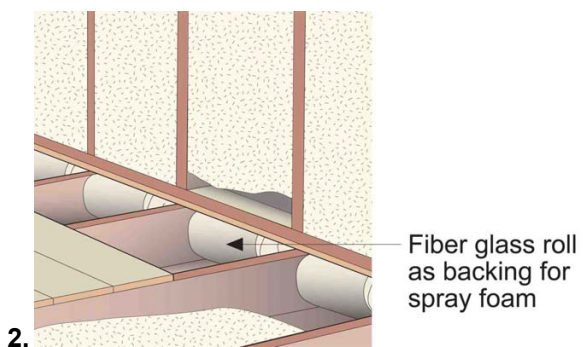
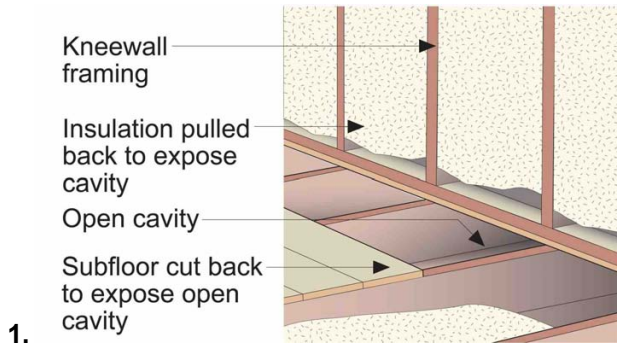

**Steps – Alternate Method with Spray Foam**

- Expose approximately an 18-inch attic joist area under the kneewall. [1]
- Roll up a fiber glass batt and friction fit it to fill the floor joist cavity under the kneewall to provide a **Backing** for spray foam. [2]
- Spray foam full cavity height and width against the **Backing**. [3]
- Install insulating sheathing over kneewall framing. [4]

**Detail ready for insulation [4]**

**Terminology**

- Air Barrier Material (ABM)** --- Any rigid or semi rigid material that does not allow air to pass through it. Examples: gypsum board, plywood/OSB, foam board, duct board, sheet metal or dimensional lumber.
- Backing** --- Any material that serves as a surface to which foam can be sprayed so as to provide an air barrier. Examples: rolled up fiber glass batts.
- Baffle (B)** --- Manufactured chutes that create an insulation stop and direct ventilation air flow up and over the insulation; typically rigid foam board or cardboard.
- Thermal Blocking** --- Any rigid material that keeps insulation from heat sources like chimneys or recessed lights. Examples: sheet metal and gypsum board.
- Fasteners** --- Staples, screws or nails that are used to permanently attach Thermal Blocking or ABMs to framing.
- Sealant** --- Any flexible product which when applied to the joint of two or more materials will adhere and permanently seal the joint to the passage of air. Examples: caulk, foam, and mastic.
- Fire Rated Sealant (FRS)** --- Any sealant that is UL listed for use in any details requiring an approved fire rated sealant. Example: Sealing sheet metal **ABM** to a chimney.

**TASK** – Control air leakage through wall cavity into attic space.

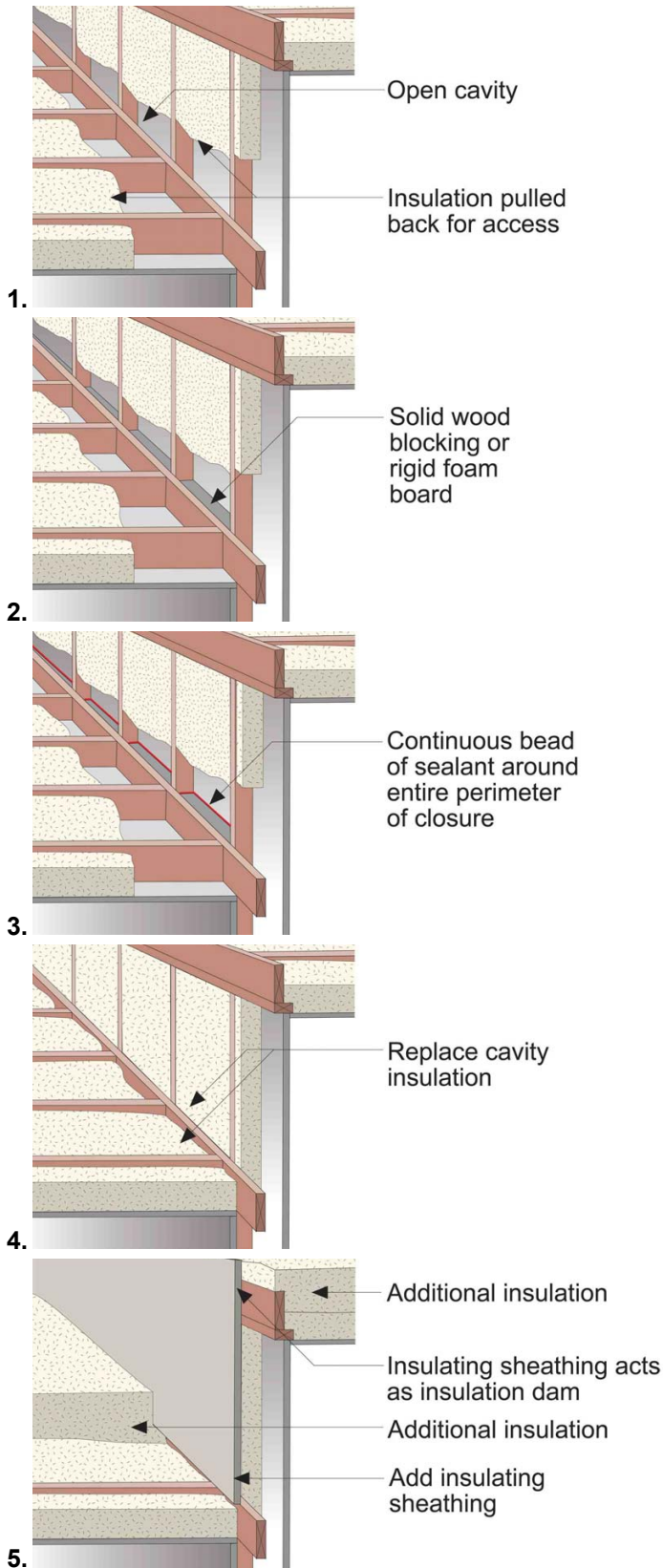

**Steps**

- Expose wall cavity area. [1]
- Pre cut **ABM** to fit cavity behind band board and Fasten. [2]
- Align **ABM** with bottom edge of band board and Sealant. [3]
- Seal all four edges of installed bottom plate with Sealant. [3]
- Install insulating sheathing over wall framing and extend upwards above top band board to act as insulation dam. [5]

**Detail ready for insulation [4,5]**

**Terminology**

**Air Barrier Material (ABM)** --- Any rigid or semi rigid material that does not allow air to pass through it. Examples: gypsum board, plywood/OSB, foam board, duct board, sheet metal or dimensional lumber.

**Backing** --- Any material that serves as a surface to which foam can be sprayed so as to provide an air barrier. Examples: rolled up fiber glass batts.

**Baffle (B)** --- Manufactured chutes that create an insulation stop and direct ventilation air flow up and over the insulation; typically rigid foam board or cardboard.

**Thermal Blocking** --- Any rigid material that keeps insulation from heat sources like chimneys or recessed lights. Examples: sheet metal and gypsum board.

**Fasteners** --- Staples, screws or nails that are used to permanently attach Thermal Blocking or ABMs to framing.

**Sealant** --- Any flexible product which when applied to the joint of two or more materials will adhere and permanently seal the joint to the passage of air. Examples: caulk, foam, and mastic.

**Fire Rated Sealant (FRS)** --- Any sealant that is UL listed for use in any details requiring an approved fire rated sealant. Example: Sealing sheet metal **ABM** to a chimney.

**TASK** – Control air leakage through wall cavity into attic space.

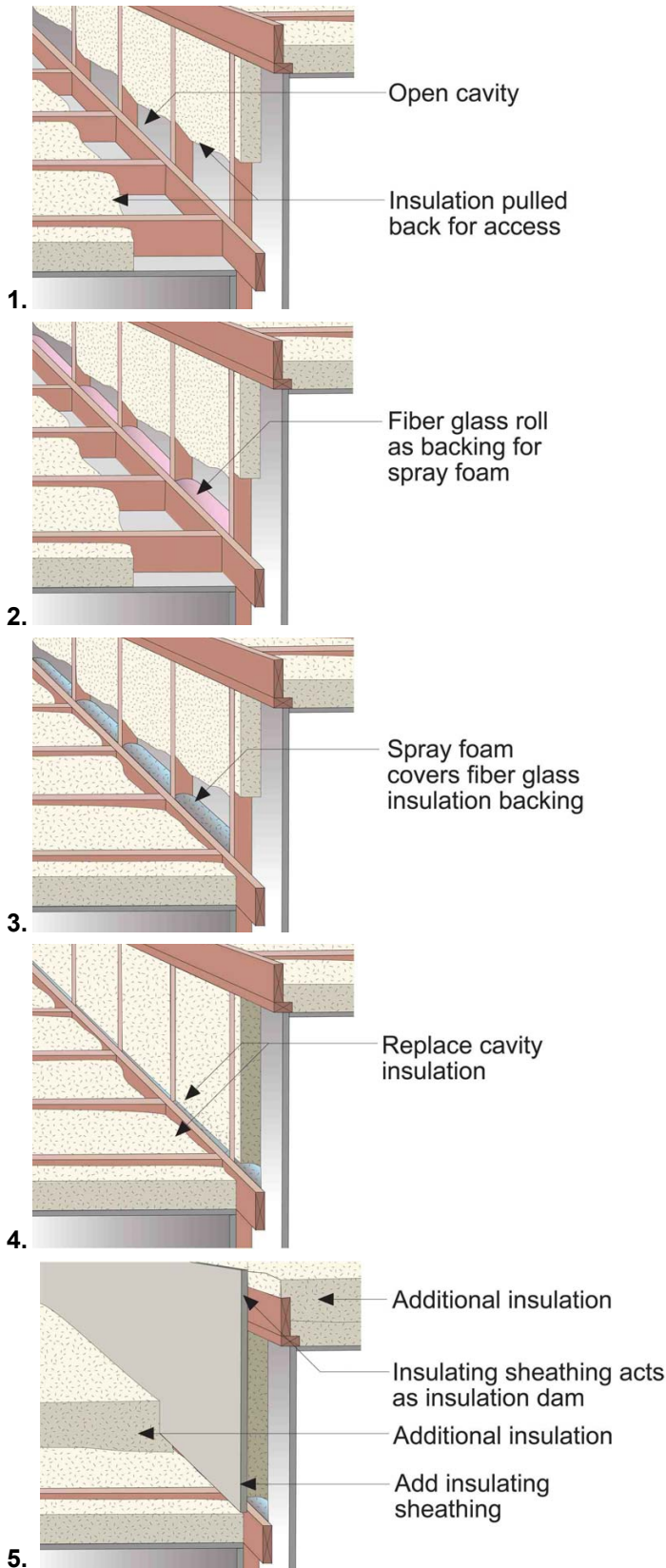

**Steps – ALTERNATE METHOD**

- Expose wall cavity area. [1]
- Friction fit **Backing** (e.g., fiber glass insulation roll) in cavity to the level of the bottom edge of the band board. Adjust so that the top of the **Backing** is at the bottom edge of the band board. [2]
- Using a foam pack, spray foam onto the **Backing** completely filling the bottom of the cavity. [3]
- Replace insulation and install insulating sheathing over wall framing and extend upwards above top band board to act as insulation dam. [5]

**Detail ready for insulation [4,5]**

**Terminology**

**Air Barrier Material (ABM)** --- Any rigid or semi rigid material that does not allow air to pass through it. Examples: gypsum board, plywood/OSB, foam board, duct board, sheet metal or dimensional lumber.

**Backing** --- Any material that serves as a surface to which foam can be sprayed so as to provide an air barrier. Examples: rolled up fiber glass batts.

**Baffle (B)** --- Manufactured chutes that create an insulation stop and direct ventilation air flow up and over the insulation; typically rigid foam board or cardboard.

**Thermal Blocking** --- Any rigid material that keeps insulation from heat sources like chimneys or recessed lights. Examples: sheet metal and gypsum board.

**Fasteners** --- Staples, screws or nails that are used to permanently attach Thermal Blocking or ABMs to framing.

**Sealant** --- Any flexible product which when applied to the joint of two or more materials will adhere and permanently seal the joint to the passage of air. Examples: caulk, foam, and mastic.

**Fire Rated Sealant (FRS)** --- Any sealant that is UL listed for use in any details requiring an approved fire rated sealant. Example: Sealing sheet metal **ABM** to a chimney.

**TASK** – Control air leakage at the bathroom fan and create an insulation shield.

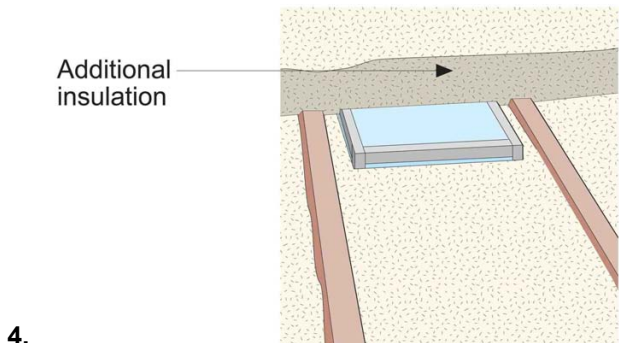
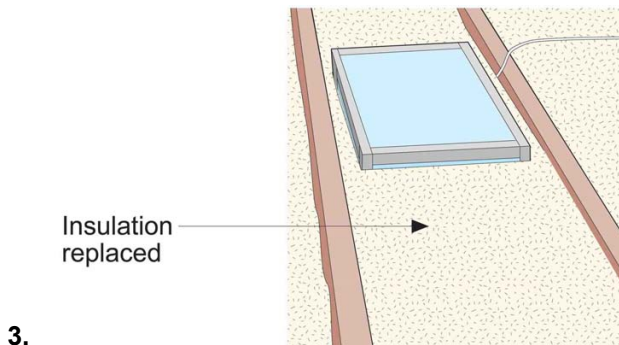
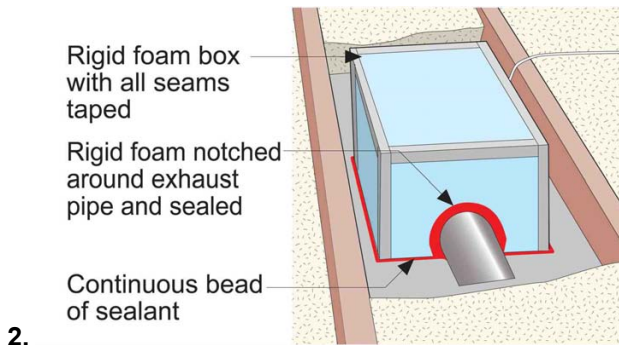
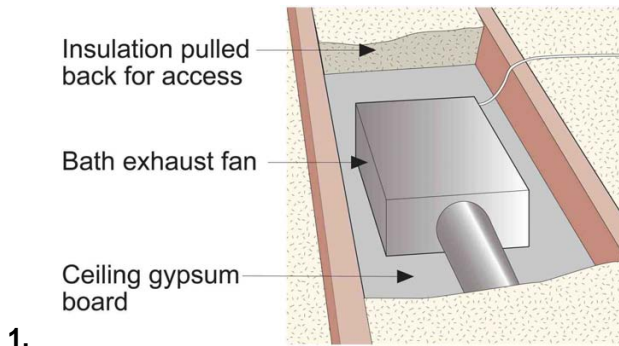

**Steps**

- Expose ceiling gypsum board approximately 12 inches both sides of fan. [1]
- Create a 5-sided box with **ABM** which will comfortably fit over the fan insuring all corners are sealed.
- Scribe and cut access in the box for exhaust duct outlet.
- Seal box to ceiling with **Sealant**.
- Seal notched **ABM** to exhaust outlet. [2]

**Detail ready for insulation [3,4]**

**Terminology**

- Air Barrier Material (ABM)** --- Any rigid or semi rigid material that does not allow air to pass through it. Examples: gypsum board, plywood/OSB, foam board, duct board, sheet metal or dimensional lumber.
- Backing** --- Any material that serves as a surface to which foam can be sprayed so as to provide an air barrier. Examples: rolled up fiber glass batts.
- Baffle (B)** --- Manufactured chutes that create an insulation stop and direct ventilation air flow up and over the insulation; typically rigid foam board or cardboard.
- Thermal Blocking** --- Any rigid material that keeps insulation from heat sources like chimneys or recessed lights. Examples: sheet metal and gypsum board.
- Fasteners** --- Staples, screws or nails that are used to permanently attach Thermal Blocking or ABMs to framing.
- Sealant** --- Any flexible product which when applied to the join of two or more materials will adhere and permanently seal the joint to the passage of air. Examples: caulk, foam, and mastic.
- Fire Rated Sealant (FRS)** --- Any sealant that is UL listed for use in any details requiring an approved fire rated sealant. Example: Sealing sheet metal **ABM** to a chimney.

**TASK** – Control air leakage at the chimney chase.

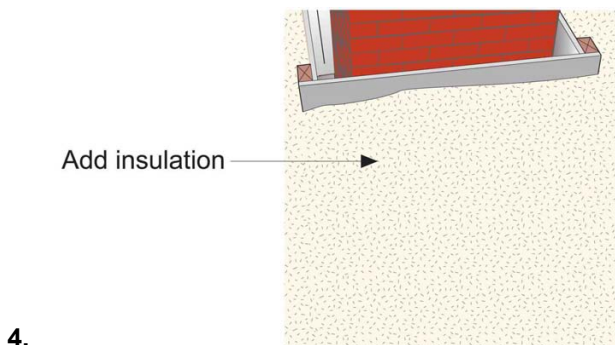
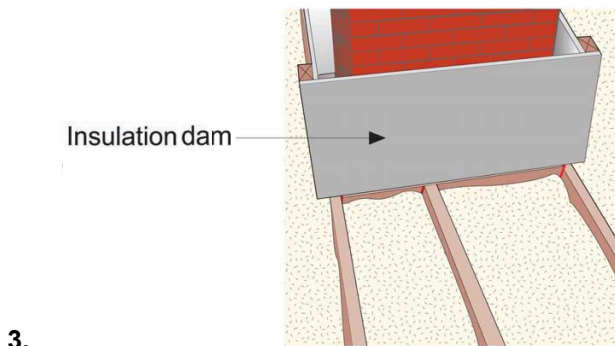
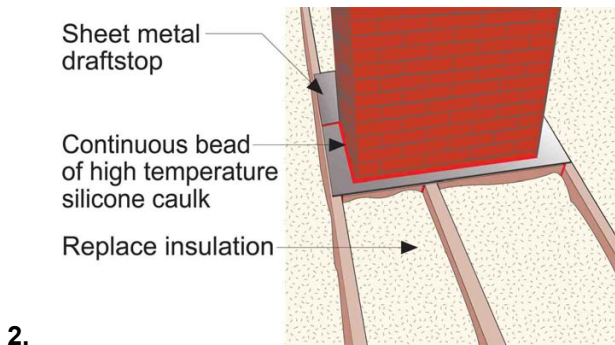
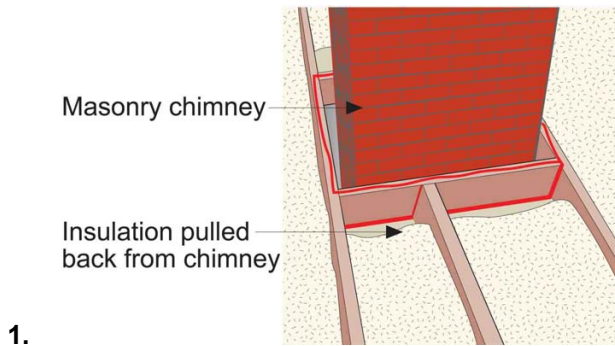

**Step 1**

- Expose all framing area. [1]
- Measure and cut sheet metal **ABM** into strips to be Fastened to framing.
- Seal all framing joints around the chase with **Sealant**. Lay a generous, continuous bead of **Sealant** along the top edge of the chase framing.
- Place sheet metal **ABM** on framing and in contact with the masonry. Tack in place with a few **Fasteners**.
- Seal the metal to the masonry with **FRS**. Also seal the metal joints. [2]

**Step 2**

- Cut insulation **Thermal Blocking** material to keep insulation at least 3 inches from the chimney. **Thermal Blocking** should be at least 4 inches higher than final insulation level.
- Fasten **Thermal Blocking** to framing. [3]

**Detail ready for insulation [4]**

**Terminology**

- Air Barrier Material (ABM)** --- Any rigid or semi rigid material that does not allow air to pass through it. Examples: gypsum board, plywood/OSB, foam board, duct board, sheet metal or dimensional lumber.
- Backing** --- Any material that serves as a surface to which foam can be sprayed so as to provide an air barrier. Examples: rolled up fiber glass batts.
- Baffle (B)** --- Manufactured chutes that create an insulation stop and direct ventilation air flow up and over the insulation; typically rigid foam board or cardboard.
- Thermal Blocking** --- Any rigid material that keeps insulation from heat sources like chimneys or recessed lights. Examples: sheet metal and gypsum board.
- Fasteners** --- Staples, screws or nails that are used to permanently attach Thermal Blocking or ABMs to framing.
- Sealant** --- Any flexible product which when applied to the joint of two or more materials will adhere and permanently seal the joint to the passage of air. Examples: caulk, foam, and mastic.
- Fire Rated Sealant (FRS)** --- Any sealant that is UL listed for use in any details requiring an approved fire rated sealant. Example: Sealing sheet metal **ABM** to a chimney.

**TASK** – Control air leakage at the metal chimney pipe chase and provide **Thermal Blocking** to separate insulation from the metal chimney vent pipe.

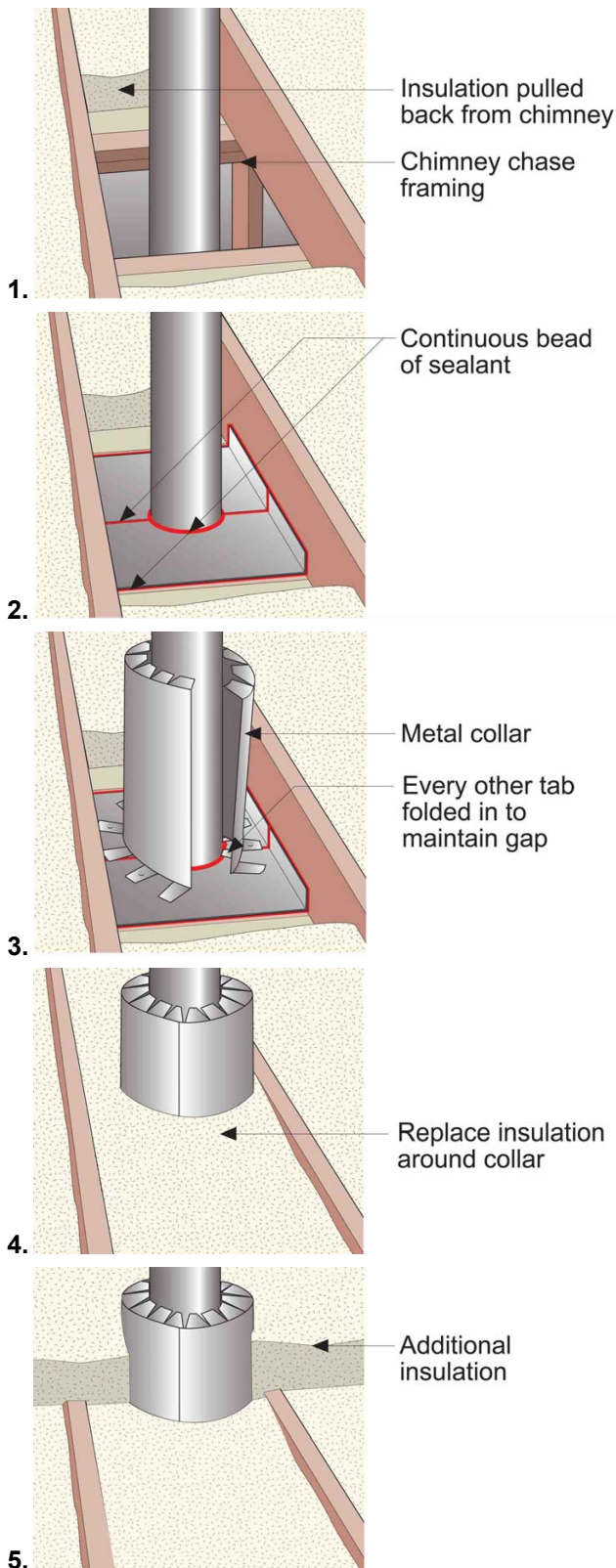

**Step 1 – Seal Chase**

- Expose the chase including the framing. [1]
- Precut two pieces of sheet metal **ABM** to cover the chase opening allowing for approximately a 1-inch overlap in center.
- Scribe and cut two half circles in the **ABM** so that it fits around the vent pipe with approximately a 1-inch overlap while covering the chase.
- Fasten the two halves of the metal **ABM** to the adjacent framing while enclosing the chimney vent pipe.
- Seal the overlap and joint of the **ABM** to the metal chimney vent pipe with **FRS**.
- Seal all edges of the **ABM** to framing with **Sealant**. [2]

**Step 2 – Insulation Thermal Blocking**

- Manufacture an insulation shield (**Thermal Blocking**) from metal coil stock so that a 3-inch clearance is provided between the insulation shield (**Thermal Blocking**) and the metal chimney vent pipe. Shield height should be 4 inches taller than the finished insulation level.
- Fasten insulation **Thermaling** to **ABM**, maintaining the 3-inch clearance.
- Ensure that there is a top cover of the 3-inch gap so that insulation does not accidentally fall into the gap. [4]

**Detail ready for insulation [5]**

**Terminology**

- Air Barrier Material (ABM)** --- Any rigid or semi rigid material that does not allow air to pass through it. Examples: gypsum board, plywood/OSB, foam board, duct board, sheet metal or dimensional lumber.
- Backing** --- Any material that serves as a surface to which foam can be sprayed so as to provide an air barrier. Examples: rolled up fiber glass batts.
- Baffle (B)** --- Manufactured chutes that create an insulation stop and direct ventilation air flow up and over the insulation; typically rigid foam board or cardboard.
- Thermal Blocking** --- Any rigid material that keeps insulation from heat sources like chimneys or recessed lights. Examples: sheet metal and gypsum board.
- Fasteners** --- Staples, screws or nails that are used to permanently attach Thermal Blocking or ABMs to framing.
- Sealant** --- Any flexible product which when applied to the joint of two or more materials will adhere and permanently seal the joint to the passage of air. Examples: caulk, foam, and mastic.
- Fire Rated Sealant (FRS)** --- Any sealant that is UL listed for use in any details requiring an approved fire rated sealant. Example: Sealing sheet metal **ABM** to a chimney.

**TASK** – Control air leakage at the metal chimney pipe chase and provide **Thermal Blocking** to separate insulation from the metal chimney vent pipe.

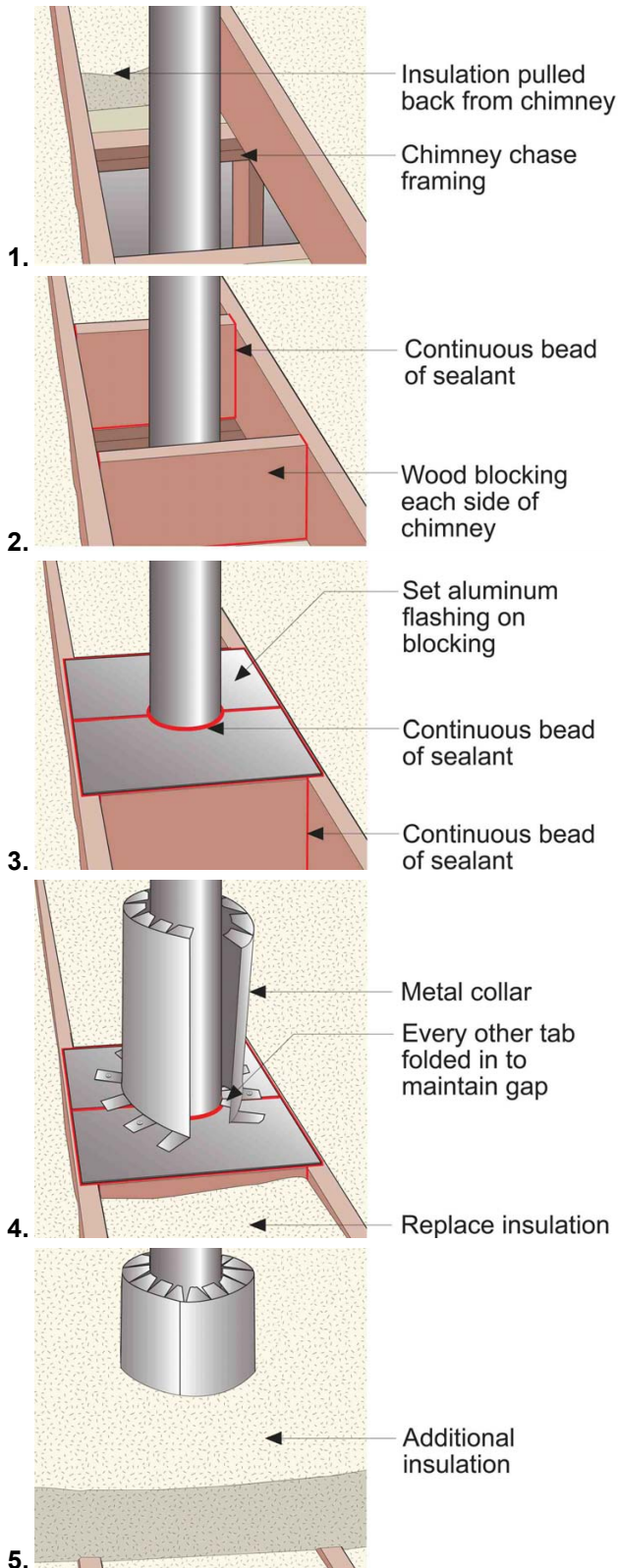

**Step 1 – Seal Chase – ALTERNATE METHOD**

- Expose the chase including framing. [1]
- Cut two cross pieces of framing lumber of equal height of ceiling joists to form a box around the pipe.
- Mechanically Fasten wood cross pieces to joists making sure that the wood is at least 3 inches from pipe. [2]
- Scribe and cut two half circles in the ABM so that it fits around the vent pipe with approximately a 1 inch overlap while covering the chase.
- Lay a generous, continuous bead of Sealant on the top edge of the framed box and all joints of the box.
- Fasten the two halves of the metal ABM to accompanying framing while enclosing the pipe.
- Seal the overlap and join of the ABM to the vent pipe with FRS. [3]

**Step 2 – Insulation Thermal Blocking**

- Manufacture an insulation shield (**Thermal Blocking**) from metal coil stock so that a 3-inch clearance is provided between the insulation shield (**Thermal Blocking**) and the metal chimney vent pipe. Shield height should be 4 inches taller than the finished insulation level.
- Fasten insulation **Thermal Blocking** to **ABM**, maintaining the 3-inch clearance.
- Ensure that there is a top cover of the 3-inch gap so that insulation does not accidentally fall into the gap. [4]

**Detail ready for insulation [5]**

**Terminology**

- Air Barrier Material (ABM)** --- Any rigid or semi rigid material that does not allow air to pass through it. Examples: gypsum board, plywood/OSB, foam board, duct board, sheet metal or dimensional lumber.
- Backing** --- Any material that serves as a surface to which foam can be sprayed so as to provide an air barrier. Examples: rolled up fiber glass batts.
- Baffle (B)** --- Manufactured chutes that create an insulation stop and direct ventilation air flow up and over the insulation; typically rigid foam board or cardboard.
- Thermal Blocking** --- Any rigid material that keeps insulation from heat sources like chimneys or recessed lights. Examples: sheet metal and gypsum board.
- Fasteners** --- Staples, screws or nails that are used to permanently attach Thermal Blocking or ABMs to framing.
- Sealant** --- Any flexible product which when applied to the joint of two or more materials will adhere and permanently seal the joint to the passage of air. Examples: caulk, foam, and mastic.
- Fire Rated Sealant (FRS)** --- Any sealant that is UL listed for use in any details requiring an approved fire rated sealant. Example: Sealing sheet metal **ABM** to a chimney.

**TASK** – Control air leakage at the duct boot ceiling penetration.

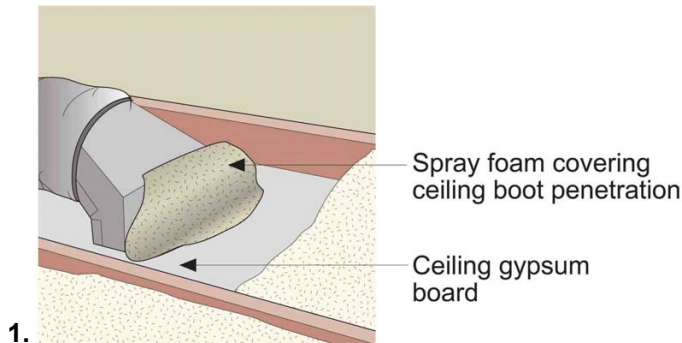

1.

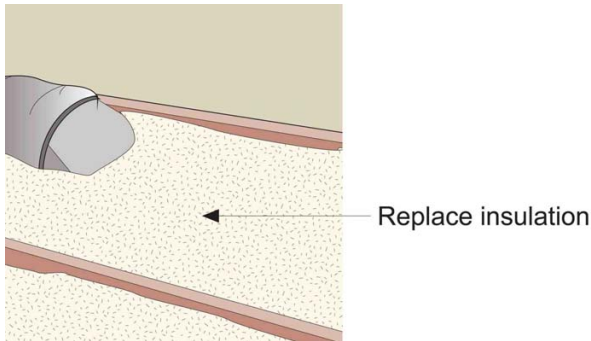

2.

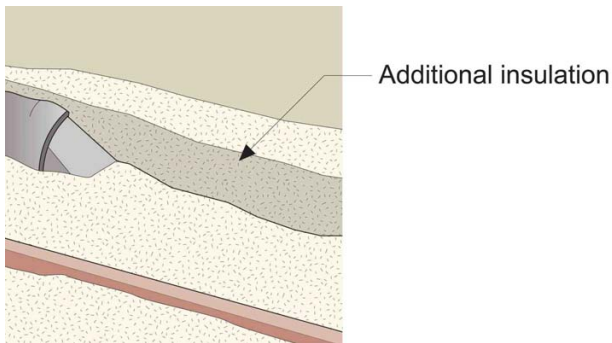

3.

**Alternate Method**

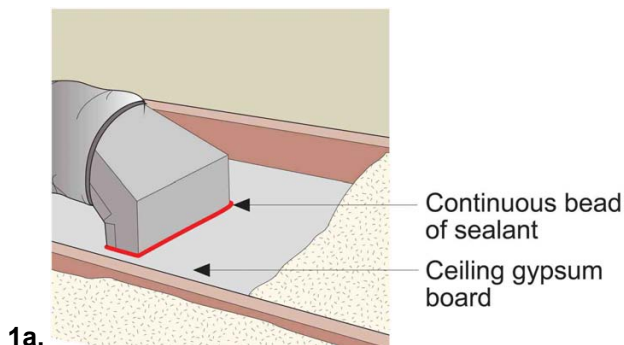

1a.

**Steps**

- Expose duct boot.
- Seal all sides of the duct boot to the gypsum board with a bead of 2.0 pounds per cubic foot spray foam. [1,1a]

**Detail ready for insulation [2,3]**

**Terminology**

- Air Barrier Material (ABM)** --- Any rigid or semi rigid material that does not allow air to pass through it. Examples: gypsum board, plywood/OSB, foam board, duct board, sheet metal or dimensional lumber.
- Backing** --- Any material that serves as a surface to which foam can be sprayed so as to provide an air barrier. Examples: rolled up fiber glass batts.
- Baffle (B)** --- Manufactured chutes that create an insulation stop and direct ventilation air flow up and over the insulation; typically rigid foam board or cardboard.
- Thermal Blocking** --- Any rigid material that keeps insulation from heat sources like chimneys or recessed lights. Examples: sheet metal and gypsum board.
- Fasteners** --- Staples, screws or nails that are used to permanently attach Thermal Blocking or ABMs to framing.
- Sealant** --- Any flexible product which when applied to the joint of two or more materials will adhere and permanently seal the joint to the passage of air. Examples: caulk, foam, and mastic.
- Fire Rated Sealant (FRS)** --- Any sealant that is UL listed for use in any details requiring an approved fire rated sealant. Example: Sealing sheet metal **ABM** to a chimney.



**TASK** – Control air leakage through the electrical box and around the electrical box.

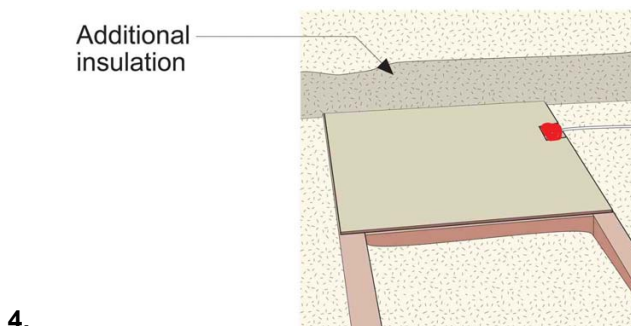
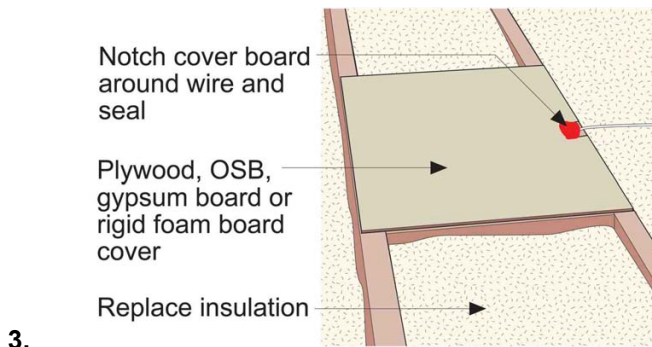
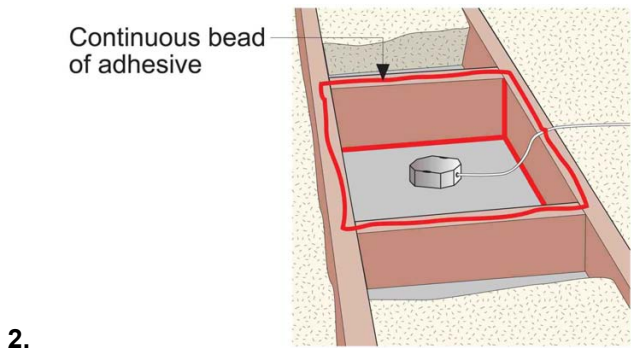
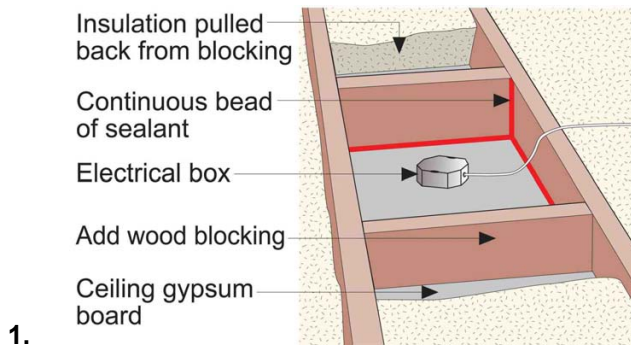

### Steps

- Expose box and approximately 12 inches of ceiling gypsum board.
- Cut two cross pieces of framing lumber of equal height of ceiling joists to form a box around the box.
- Mechanically **Fasten** wood cross pieces to joists making sure that the wood is at least 3 inches from box. [1]
- Pre cut **ABM** to form cover for box with a cut out for the wire.
- Seal all framing joints of the box and lay a generous, continuous bead of **Sealant** along top edge of box.
- Place **ABM** onto box frame firmly and tack with a few **Fasteners** [2,3].
- Seal wire cutout with **Sealant**.

**Detail ready for insulation [3,4]**

### Terminology

**Air Barrier Material (ABM)** --- Any rigid or semi rigid material that does not allow air to pass through it. Examples: gypsum board, plywood/OSB, foam board, duct board, sheet metal or dimensional lumber.

**Backing** --- Any material that serves as a surface to which foam can be sprayed so as to provide an air barrier. Examples: rolled up fiber glass batts.

**Baffle (B)** --- Manufactured chutes that create an insulation stop and direct ventilation air flow up and over the insulation; typically rigid foam board or cardboard.

**Thermal Blocking** --- Any rigid material that keeps insulation from heat sources like chimneys or recessed lights. Examples: sheet metal and gypsum board.

**Fasteners** --- Staples, screws or nails that are used to permanently attach Thermal Blocking or ABMs to framing.

**Sealant** --- Any flexible product which when applied to the joint of two or more materials will adhere and permanently seal the joint to the passage of air. Examples: caulk, foam, and mastic.

**Fire Rated Sealant (FRS)** --- Any sealant that is UL listed for use in any details requiring an approved fire rated sealant. Example: Sealing sheet metal **ABM** to a chimney.

**TASK** – Control air leakage through the electrical box and around the electrical box.

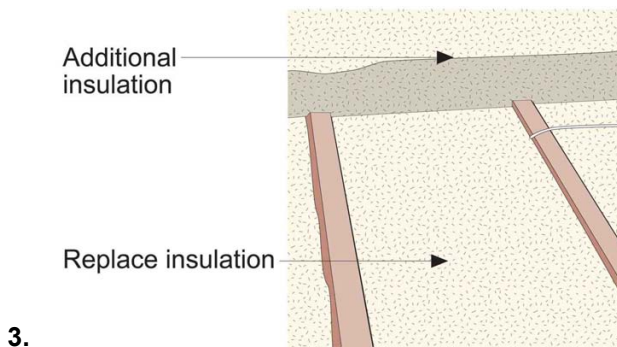
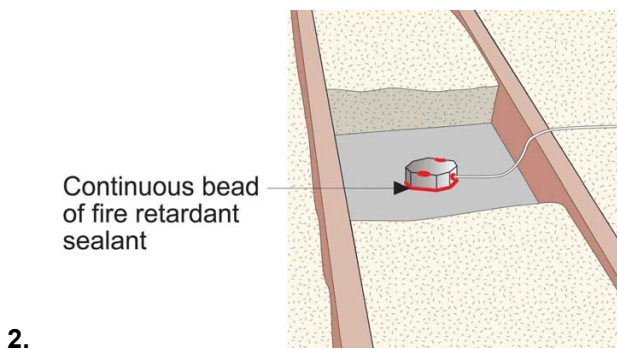
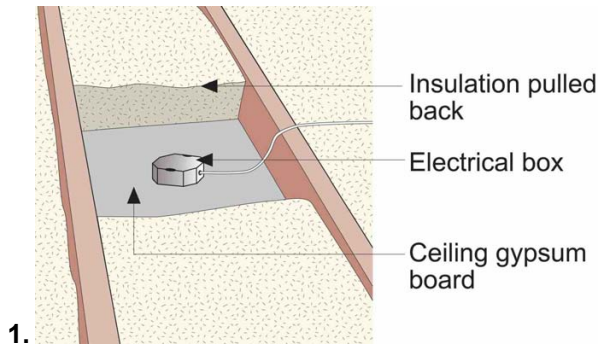

### Steps – Alternative Method

- Expose box and approximately 12 inches of ceiling gypsum board [1].
- Seal the box to the gypsum board, wire entry points and any box openings with FRS [2].

### Detail ready for insulation [3]

### Terminology

**Air Barrier Material (ABM)** --- Any rigid or semi rigid material that does not allow air to pass through it. Examples: gypsum board, plywood/OSB, foam board, duct board, sheet metal or dimensional lumber.

**Backing** --- Any material that serves as a surface to which foam can be sprayed so as to provide an air barrier. Examples: rolled up fiber glass batts.

**Baffle (B)** --- Manufactured chutes that create an insulation stop and direct ventilation air flow up and over the insulation; typically rigid foam board or cardboard.

**Thermal Blocking** --- Any rigid material that keeps insulation from heat sources like chimneys or recessed lights. Examples: sheet metal and gypsum board.

**Fasteners** --- Staples, screws or nails that are used to permanently attach Thermal Blocking or ABMs to framing.

**Sealant** --- Any flexible product which when applied to the joint of two or more materials will adhere and permanently seal the joint to the passage of air. Examples: caulk, foam, and mastic.

**Fire Rated Sealant (FRS)** --- Any sealant that is UL listed for use in any details requiring an approved fire rated sealant. Example: Sealing sheet metal **ABM** to a chimney.

**TASK** – Control air leakage at the penetration.

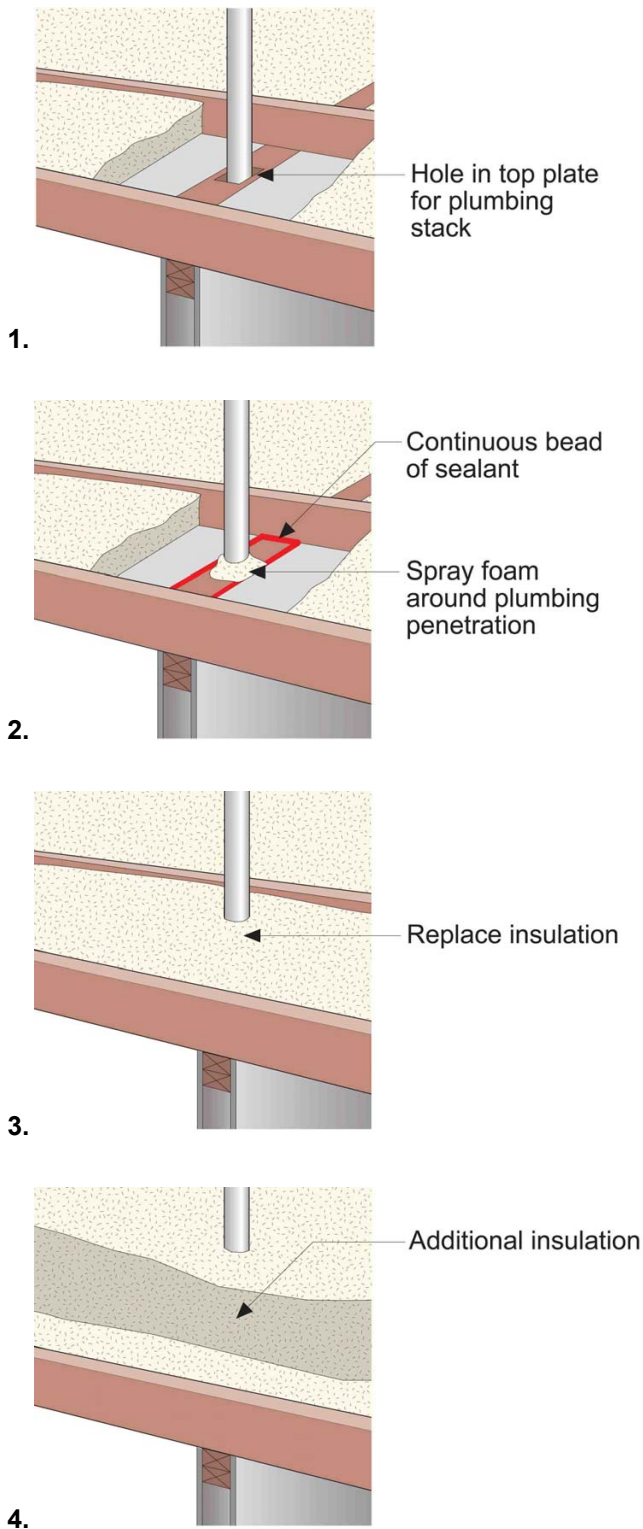

**Steps**

- Expose all of top plate and plumbing stack. [1]
- Seal the top plate with Sealant and the plumbing stack with foam. Note that spray foam sealant used in this application must have an acceptable rating as a fireblocking material. [2]

**Detail ready for insulation [3,4]**

**Terminology**

**Air Barrier Material (ABM)** --- Any rigid or semi rigid material that does not allow air to pass through it. Examples: gypsum board, plywood/OSB, foam board, duct board, sheet metal or dimensional lumber.

**Backing** --- Any material that serves as a surface to which foam can be sprayed so as to provide an air barrier. Examples: rolled up fiber glass batts.

**Baffle (B)** --- Manufactured chutes that create an insulation stop and direct ventilation air flow up and over the insulation; typically rigid foam board or cardboard.

**Thermal Blocking** --- Any rigid material that keeps insulation from heat sources like chimneys or recessed lights. Examples: sheet metal and gypsum board.

**Fasteners** --- Staples, screws or nails that are used to permanently attach Thermal Blocking or ABMs to framing.

**Sealant** --- Any flexible product which when applied to the joint of two or more materials will adhere and permanently seal the joint to the passage of air. Examples: caulk, foam, and mastic.

**Fire Rated Sealant (FRS)** --- Any sealant that is UL listed for use in any details requiring an approved fire rated sealant. Example: Sealing sheet metal **ABM** to a chimney.

**TASK** – Control air leakage through the ceiling light, control air leakage between the ceiling light and gypsum board ceiling and create an insulation shield (**Thermal Block**).

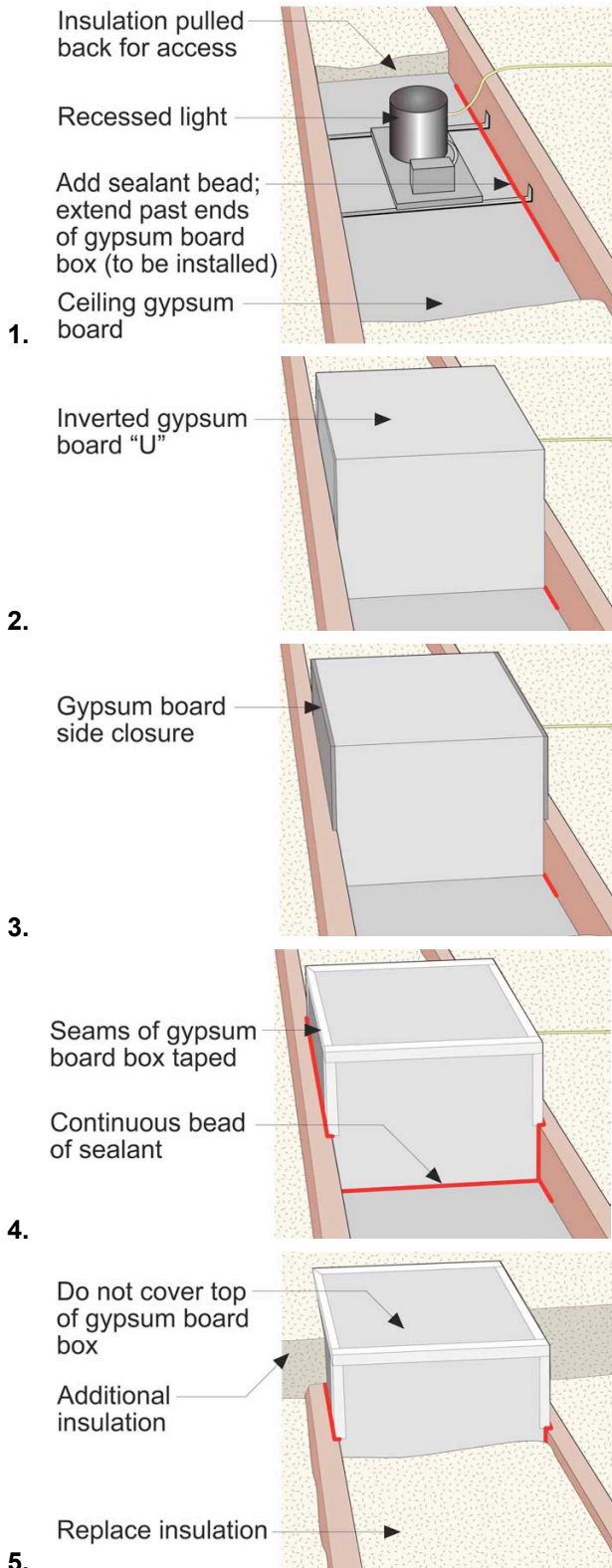

**Steps**

- Expose ceiling gypsum board approximately 12 inches both sides of the recessed can. Add Sealant at joist to gypsum board joint, extending past ends of gypsum board box (see below) [1]
- Precut 5/8 piece of drywall 42 inches long by 22 1/2" (for 24" o.c. ceiling joist spacing) or 14 1/2" (for 16" o.c. spacing). [A]
- Score back side of gypsum board stock at 12 inches from ends. [B] Break along scored lines and form an inverted "U" shape of **ABM** to keep insulation 3" from can. [2]
- Install gypsum board side closure. [3]
- Tape seams of gypsum board box and join to ceiling with Sealant. [4]
- Replace bulb with compact fluorescent (CLF) bulb (less than 60 watts) to reduce heat build-up.

**Detail ready for insulation [5]**

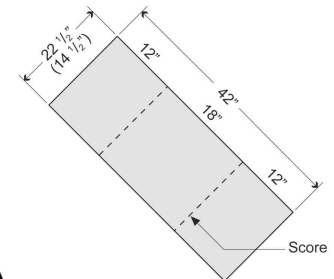

A.

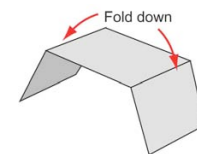

B.

**Terminology**

- Air Barrier Material (ABM)** --- Any rigid or semi rigid material that does not allow air to pass through it. Examples: gypsum board, plywood/OSB, foam board, duct board, sheet metal or dimensional lumber.
- Backing** --- Any material that serves as a surface to which foam can be sprayed so as to provide an air barrier. Examples: rolled up fiber glass batts.
- Baffle (B)** --- Manufactured chutes that create an insulation stop and direct ventilation air flow up and over the insulation; typically rigid foam board or cardboard.
- Thermal Blocking** --- Any rigid material that keeps insulation from heat sources like chimneys or recessed lights. Examples: sheet metal and gypsum board.
- Fasteners** --- Staples, screws or nails that are used to permanently attach Thermal Blocking or ABMs to framing.
- Sealant** --- Any flexible product which when applied to the joint of two or more materials will adhere and permanently seal the joint to the passage of air. Examples: caulk, foam, and mastic.
- Fire Rated Sealant (FRS)** --- Any sealant that is UL listed for use in any details requiring an approved fire rated sealant. Example: Sealing sheet metal **ABM** to a chimney.

**TASK** – Control air leakage at the duct chase.

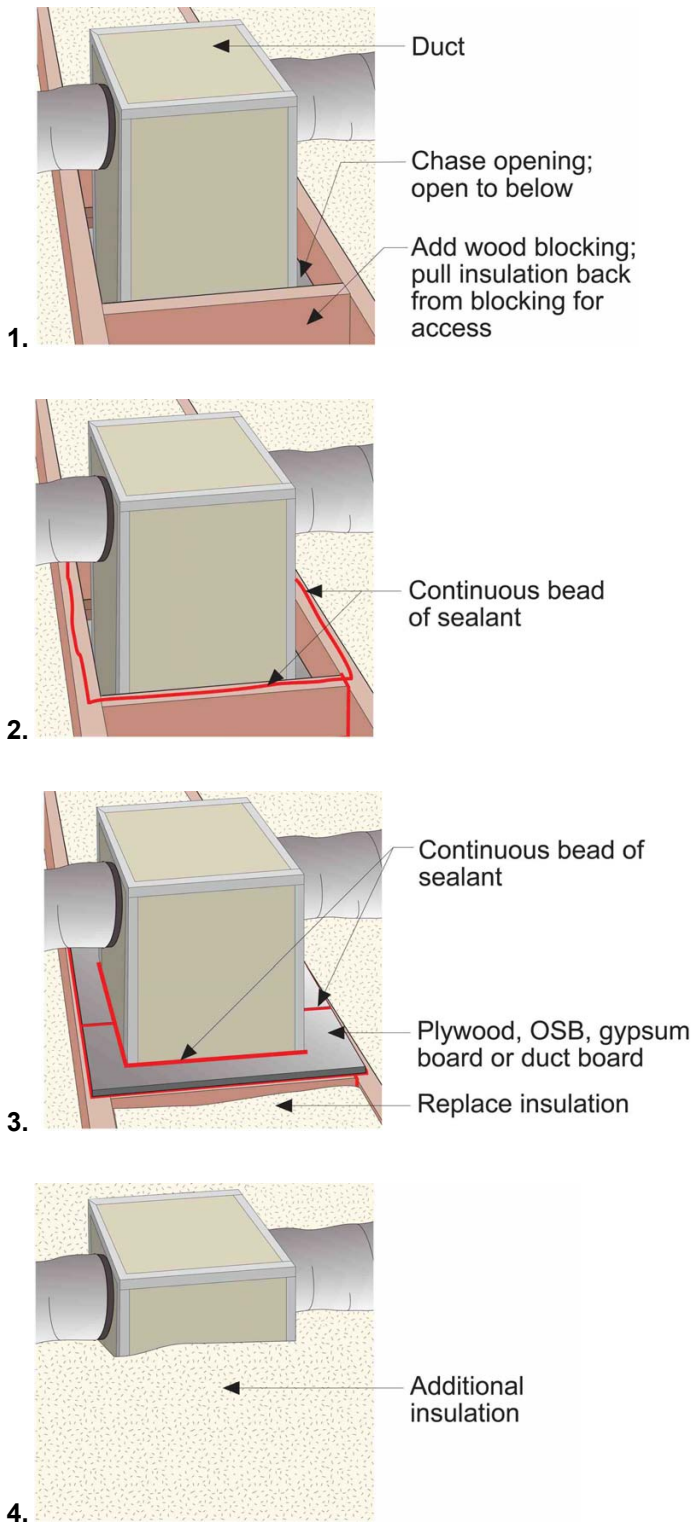

**Steps**

- Expose the chase and the framing area. [1]
- Measure and cut **ABM** into strips to be Fastened to framing.
- Seal all framing joints around the chase with **Sealant**. Lay a generous continuous bead of **Sealant** along the top edge of the chase framing. [2]
- Place **ABM** on framing leaving 1/4 inch gap between rigid duct and **ABM**. Fasten in place with **Fasteners**.
- Seal the **ABM** to the duct with **Sealant**. Also seal the joints in the **ABM**. [3]

**Detail ready for insulation [4]**

**Terminology**

- Air Barrier Material (ABM)** --- Any rigid or semi rigid material that does not allow air to pass through it. Examples: gypsum board, plywood/OSB, foam board, duct board, sheet metal or dimensional lumber.
- Backing** --- Any material that serves as a surface to which foam can be sprayed so as to provide an air barrier. Examples: rolled up fiber glass batts.
- Baffle (B)** --- Manufactured chutes that create an insulation stop and direct ventilation air flow up and over the insulation; typically rigid foam board or cardboard.
- Thermal Blocking** --- Any rigid material that keeps insulation from heat sources like chimneys or recessed lights. Examples: sheet metal and gypsum board.
- Fasteners** --- Staples, screws or nails that are used to permanently attach Thermal Blocking or ABMs to framing.
- Sealant** --- Any flexible product which when applied to the join of two or more materials will adhere and permanently seal the joint to the passage of air. Examples: caulk, foam, and mastic.
- Fire Rated Sealant (FRS)** --- Any sealant that is UL listed for use in any details requiring an approved fire rated sealant. Example: Sealing sheet metal **ABM** to a chimney.

**TASK** – Control air leakage at the duct chase.

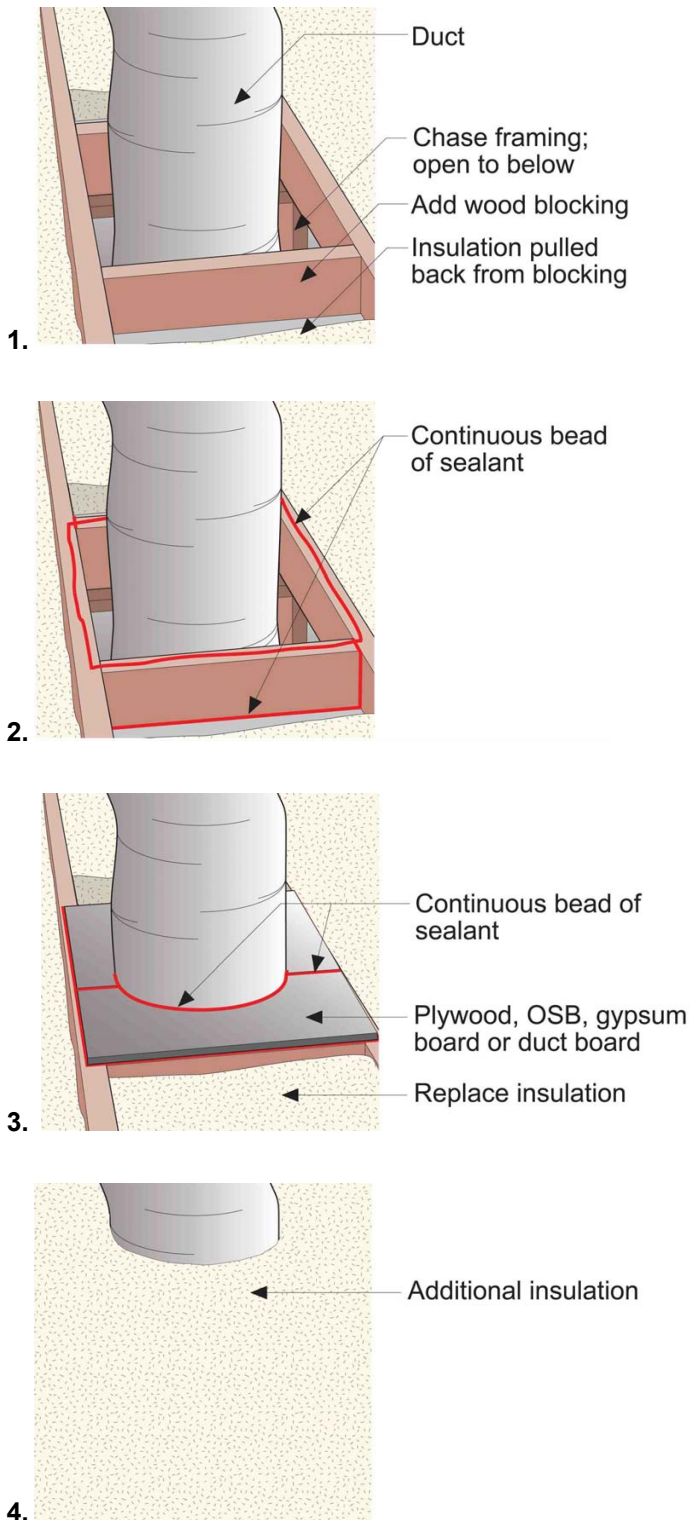

**Steps**

- Expose the chase and the framing area. [1]
- Measure and cut **ABM** to cover entire chase.
- Cut the **ABM** into two halves and then cut half circles to encompass the flex duct.
- Seal all framing joints around the chase with **Sealant**. Lay a generous continuous bead of **Sealant** along the top edge of the chase framing. [2]
- Place **ABM** on framing and in contact with the duct. Fasten in place with **Fasteners**.
- Seal the **ABM** to the duct with **Sealant**. Also seal the joints in the **ABM**. [3]

**Detail ready for insulation [4]**

**Terminology**

- Air Barrier Material (ABM)** --- Any rigid or semi rigid material that does not allow air to pass through it. Examples: gypsum board, plywood/OSB, foam board, duct board, sheet metal or dimensional lumber.
- Backing** --- Any material that serves as a surface to which foam can be sprayed so as to provide an air barrier. Examples: rolled up fiber glass batts.
- Baffle (B)** --- Manufactured chutes that create an insulation stop and direct ventilation air flow up and over the insulation; typically rigid foam board or cardboard.
- Thermal Blocking** --- Any rigid material that keeps insulation from heat sources like chimneys or recessed lights. Examples: sheet metal and gypsum board.
- Fasteners** --- Staples, screws or nails that are used to permanently attach Thermal Blocking or ABMs to framing.
- Sealant** --- Any flexible product which when applied to the join of two or more materials will adhere and permanently seal the joint to the passage of air. Examples: caulk, foam, and mastic.
- Fire Rated Sealant (FRS)** --- Any sealant that is UL listed for use in any details requiring an approved fire rated sealant. Example: Sealing sheet metal **ABM** to a chimney.

**TASK** – Control air leakage between top plates and ceiling gypsum board and control leakage at electrical and plumbing penetrations.

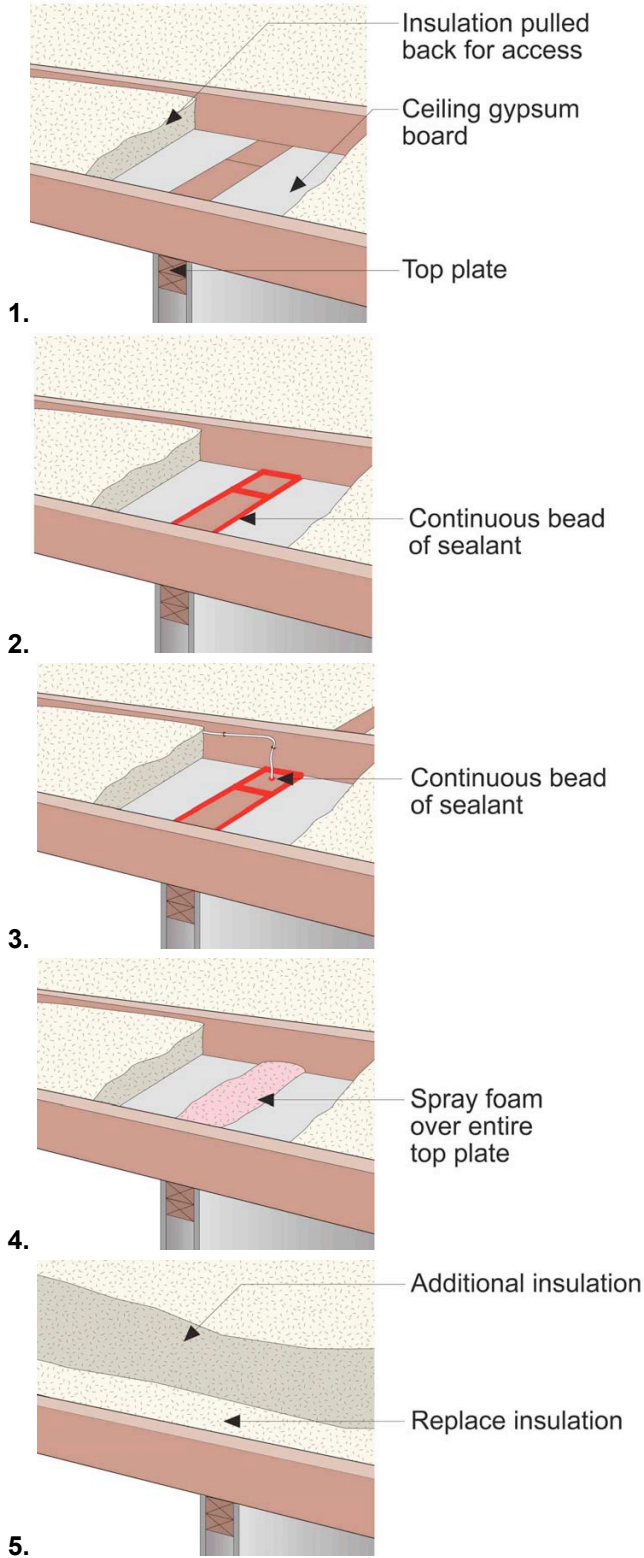

**Steps**

- Locate and expose all top plates. [1]
- Air seal all joints of drywall to framing and any penetrations with appropriate Sealant. [2,3]

**Alternate Method using Foam Pack**

- Locate and expose all top plates. [1]
- Choose a foam dispenser tip that will create a fan of approximately 5 inches.
- Spray a continuous layer of foam so as to totally cover the width of the top plate and adhere to the gypsum board on both sides of the framing. [4]

**Details ready for insulation [5]**

**Terminology**

- Air Barrier Material (ABM)** --- Any rigid or semi rigid material that does not allow air to pass through it. Examples: gypsum board, plywood/OSB, foam board, duct board, sheet metal or dimensional lumber.
- Backing** --- Any material that serves as a surface to which foam can be sprayed so as to provide an air barrier. Examples: rolled up fiber glass batts.
- Baffle (B)** --- Manufactured chutes that create an insulation stop and direct ventilation air flow up and over the insulation; typically rigid foam board or cardboard.
- Thermal Blocking** --- Any rigid material that keeps insulation from heat sources like chimneys or recessed lights. Examples: sheet metal and gypsum board.
- Fasteners** --- Staples, screws or nails that are used to permanently attach Thermal Blocking or ABMs to framing.
- Sealant** --- Any flexible product which when applied to the joint of two or more materials will adhere and permanently seal the joint to the passage of air. Examples: caulk, foam, and mastic.
- Fire Rated Sealant (FRS)** --- Any sealant that is UL listed for use in any details requiring an approved fire rated sealant. Example: Sealing sheet metal **ABM** to a chimney.